



PRICE LIST MAY 2024
RETAIL PRICES EXCL. VAT
PRICE IN EUR



MAGNUS OLESEN

INDEX

INDEXS	2		
DANISH DESIGN	3		
GOOD DESIGN, THAT LASTS	4		
QUICK SHIP	5		
SERIES		SEATING LINES	
8000 SERIES	6	Ø CHAIR	37
8000 SERIES CHAIR	7	Ø CHAIR - 9 SELECTED VARIANTS	38
8000 SERIES STOOL	8	Ø CHAIR	39
X-LINE SERIES	9	PAUSE	40
X-LINE CHAIR	10	PAUSE	41
X-LINE TABLE	11	PAUSE WITH ARMREST	42
FREYA SERIES	12	PAUSE WITH ARMREST (FORWARD)	43
FREYA	13	PAUSE RUNNER	44
FREYA TWO	14	PAUSE BAR STOOL	45
FREYA ARM	15	INFERNO	46
FREYA LOUNGE	16	INFERNO	47
FREYA BENCH	17	SESSION SERIES	48
FREYA DESK	18	SESSION PURE	49
FREYA COFFEE TABLE	19	SESSION	50
FREYA DINING TABLE	20	45-SERIES	51
BUTTERFLY SERIES	21	45-SERIES	52
BUTTERFLY WITH 4 STEEL LEGS	22	45-SERIES WITH ARMREST	53
BUTTERFLY WITH 4 STEEL LEGS & ARM	23	TONICA WOOD	54
BUTTERFLY SWIVEL	24	TONICA WOOD	55
BUTTERFLY SWIVEL WITH ARMREST	25	TONICA WOOD WITH ARMREST	56
BUTTERFLY SWIVEL HIGH	26	SOLACIA	57
BUTTERFLY SWIVEL HIGH WITH ARM	27	SOLACIA CHAIR & STOOL	58
BUTTERFLY WOOD	28	ADDI MEETING	59
BUTTERFLY CLASSIC ARMCHAIR	29	ADDI MEETING	60
BUTTERFLY CLASSIC LOUNGE	30		
BUTTERFLY CLASSIC 2-SEATER	31		
BUTTERFLY BAR	32		
MODEL 107 SERIES	33		
MODEL 107 LOUNGE CHAIR	34		
MODEL 107 2-SEATER	35		
MODEL 107 COFFEE TABLE	36		
		TABLE LINES	
		SLENDER	61
		SLENDER	62
		SLENDER COFFEE TABLE	63
		MIX TABLE SERIES	64
		MIX, FINGER JOINT WOODEN LEGS	66
		MIX WITH CONICAL WOODEN LEGS	69
		BRUNCH TABLE SERIES	72
		BRUNCH WITH STEEL LEGS	74
		BRUNCH WITH CONICAL WOODEN LEGS	75
		CONTACT	76
		CONTACT	78
		CONTACT MEETING	79
		TRIO	80
		TRIO	81
		BAR TABLE WOOD	82
		BAR TABLE WOOD	83
		MEETING TABLE	84
		MEETING TABLE	85
		FABRIC, LEATHER & ARTIFICIAL LEATHER	86
		TERMS OF SALE AND DELIVERY	88

DANISH DESIGN - WITH PRODUCTION IN DENMARK



GOOD DESIGN, THAT LASTS

Magnus Olesen has manufactured functional, durable yet aesthetic design since 1937 - Made in Denmark.

Magnus Olesen A/S was founded in 1937 with a strong belief in Danish Design and craftsmanship. It is today a well-reputed furniture company, developing and manufacturing design furniture of high quality and durability. Over the course of time it has worked with well-respected designers such as Danish Modern designer Ib Kofod-Larsen in the 1950s, Rud Thygesen & Johnny Sørensen in the 1970s & 1980s, Says Who and Øivind Slaatto today – always remaining true to its design roots but still keeping up with the developments of time.

Due to its design history, Magnus Olesen A/S has built an extensive portfolio of both Danish classics as well as contemporary designs. Today, the designs can be seen in a multitude of architectural projects as well as in private homes. Magnus Olesen has always been focused on longevity and sustainability – good design, that lasts. The company has its production in Durup, Denmark. The showroom of Magnus Olesen is placed in beautiful surroundings in the center of Copenhagen.



GOOD DESIGN, THAT LASTS

“Not just any design will be put in production at Magnus Olesen. A design is considered as good design, when both the visual expression and well thought out function meet the environmental requirements we work with.”

– Nils Knudsen, Owner & CEO, Magnus Olesen A/S

PRODUCTION IN DENMARK

We believe in Danish craftsmanship and have produced in Denmark ever since 1937. Wood and other raw materials are converted into chairs and tables locally in Denmark. With our factory in Denmark we work purposefully for a production that meets the strictest environmental requirements.

RESPONSIBLE USE OF MATERIALS

Magnus Olesen's production is based on sustainable materials. Since 2016, Magnus Olesen has been FSC® certified (FSC® C131817). Our environmental choice applies not only to our wood but also to other materials in our production. For example, recycled materials such as composite material. In addition we offer a number of our tables with 'Honeycomb' material which secures minimal use of material. A number of our products are EU ECOLABEL certified.

CIRCULAR ECONOMY/ DESIGN FOR DISASSEMBLY

We work with circular economy and the majority of our products are designed for disassembly so that they are easy to recycle and reuse. This gives us the opportunity to offer individual 'Take Back' agreements where we upcycle our products for an even longer lifetime.

Magnus Olesen
Good design, that lasts

For more information visit magnus-olesen.com

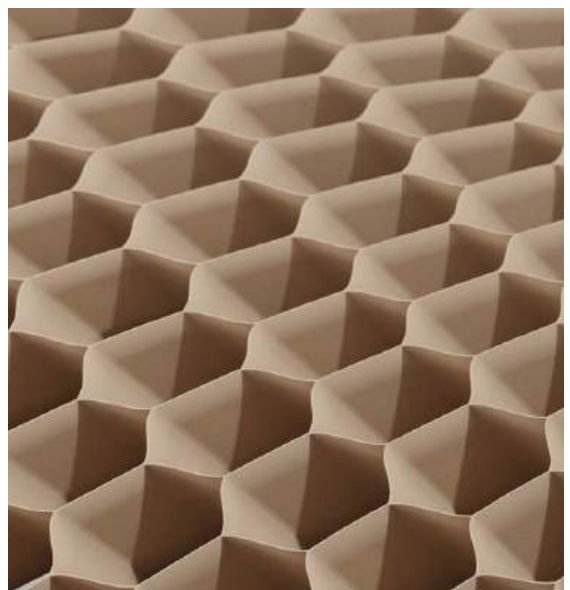

QUICK SHIP

Quick Ship program with selected products that can be shipped in a maximum of 3 weeks from receipt of order. For larger orders, please contact the factory for the current delivery time - contact post@magnus-olesen.dk.

PAUSE

Pause, MO 8661, stackable
Seat and back: Black composite
Steel frame: Matt, black grained lacquer

Ø CHAIR

Ø Chair, MO 2030, stackable
Seat and back in wood: Black painted oak
Steel frame and screw: Matt, black grained lacquer

BUTTERFLY WITH 4 STEEL LEGS

Butterfly with 4 steel legs, MO 5310, stackable
Seat and back shell: Oak with transparent lacquer
Steel frame: Matt, black grained lacquer or bright chrome

FREYA DESK

Freya Desk, MO 4760-1, size 110x45xH74 cm
Table top with black Forbo linoleum, colour no. 4023
Frame, table edge and drawer in wood: Oak with transparent lacquer

MIX TABLE SERIES

Mix tables, MO 7003 with solid, finger joint wooden legs
Table top with black Forbo linoleum, colour no. 4023
Frame and table edge in wood: Oak with transparent lacquer
MO 7003-8, size 80x120xH74 cm
MO 7003-9, size 80x140xH74 cm
MO 7003-11, size 80x180xH74 cm

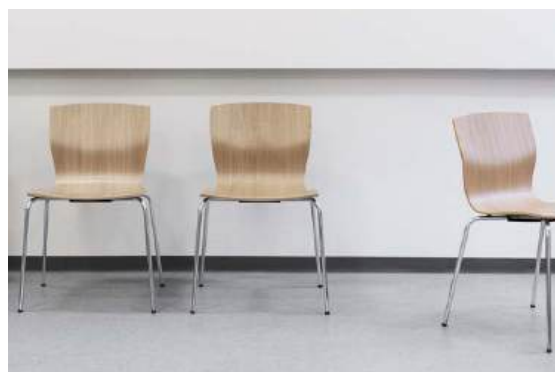

8000 SERIES

DESIGN: (1981) RUD THYGESEN & JOHNNY SØRENSEN

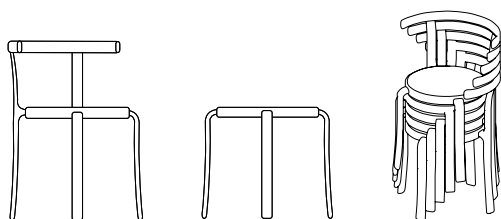

8000 series is a design icon, produced by Magnus Olesen since 1981. The series is based on a unique and patented production technology without the use of screws and dowels, which makes the furniture very flexible and incredibly strong despite its low weight. In 2021, Magnus Olesen brings the 80s to life with a relaunch of the iconic 8000 series chair in 9 new high gloss colours (Gloss 90). The series is also available in the same selected colours as the Ø Chair (Gloss 35) (see more on page 37)

WOOD & TREATMENTS

See product details on the individual product pages

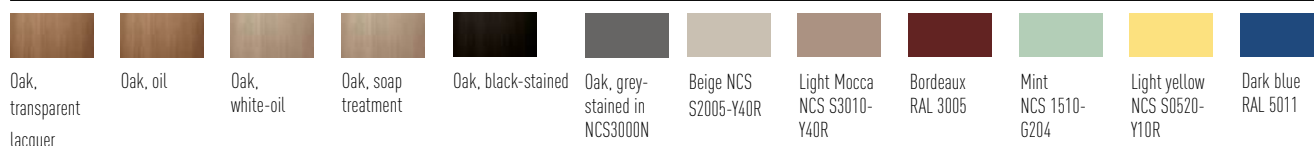

HIGH GLOSS LACQUER COLOURS

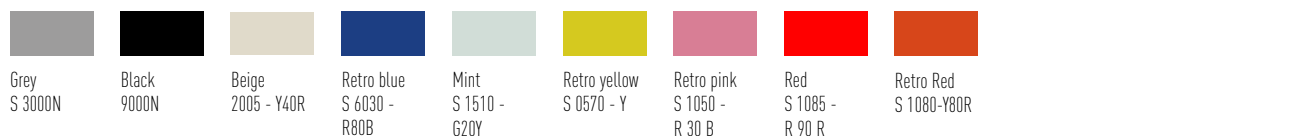

LINOLEUM

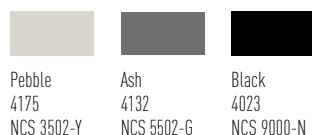

LAMINATE

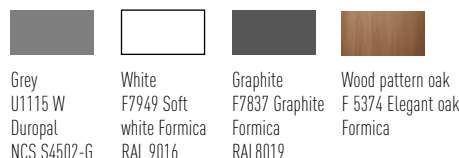

RECOMMENDED FABRIC, LEATHER & ARTIFICIAL LEATHER

GROUP A	GROUP B	GROUP C	LEATHER 1	LEATHER 2
Cura, Main Line Plus	Fame, Illusion, Synergy, Remix 3	Hallingdal 65	Sydney, Hero, Zea	Savanne, Vacona, Fauna

See the overview of fabric, leather and artificial leather on page 86

8000 SERIES CHAIR

DESIGN: (1981) RUD THYGESEN & JOHNNY SØRENSEN

SPECIFICATIONS & MEASUREMENTS

Description	Unique designed stackable chair in oak or high gloss.
Measurement	W53 x D53 x H72 x SH46 cm
Weight	Gross/Net: 4,1/3,8 kg/pc. 5 pcs/cart. 0,31 cbm/cart
Seat	Ø40 cm with option of seat in wood, linoleum, laminate, or with upholstery
Wood	Laminated beech with top veneer in oak - laquered, oiled, black-stained or in the Ø Chair 7 colours - or in high gloss laquer
Stackable	6 pcs.



8000 SERIES CHAIR

Item No.	Product			A	B	C	1	2
		Seat in wood	Linoleum Laminate					
MO 8002	Frame in oak	485	485	475	490	520	535	560
MO 8002	Frame in oak - black-stained oak or in Ø Chair 7 colours	515	515	550	565	595	615	635
MO 8002N	Frame and seat in high gloss	690						

ACCESSORIES

Item No.	Product	Prize
MO 1614	4 pcs. felt glides, white - mounted	20
MO 1615	4 pcs. plastic glides, white - mounted	20
MO 1801	Detachable seat top	35

		A	B	C	1	2
MO 1801	Detachable seat top with upholstery	110	135	160	175	195

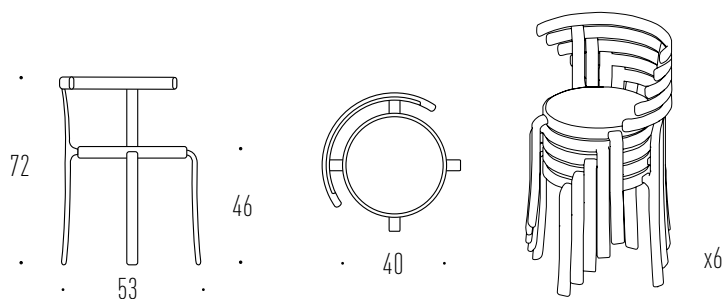

8000 SERIES STOOL

DESIGN: (1981) RUD THYGESEN & JOHNNY SØRENSEN

SPECIFICATIONS & MEASUREMENTS

Description	Unique designed stackable stool in oak or high gloss.
Measurement	W53 x D53 x H46 cm
Weight	Gross/Net: 3,47/3,13 kg/pc. 10 pcs/cart. 0,31 cbm/cart
Seat	Ø40 cm with option of seat in wood, linoleum, laminate, or with upholstery
Wood	Laminated beech with top veneer in oak - laquered, oiled, black-stained or in the Ø Chair 7 colours - or in high gloss laquer
Stackable	Stacks endlessly



8000 SERIES STOOL

Item No.	Product	Linoleum		A	B	C	1	2
		Seat in wood	Laminate					
MO 8000	Frame in oak	345	345	355	360	390	405	425
MO 8000	Frame in oak - black-stained oak or in Ø Chair 7 colours	375	375	405	415	445	460	475
MO 8000N	Frame and seat in high gloss	515						

ACCESSORIES

Item No.	Product	Prize
MO 1614	4 pcs. felt glides, white - mounted	20
MO 1615	4 pcs. plastic glides, white - mounted	20
MO 1801	Detachable seat top	35

		A	B	C	1	2
MO 1801	Detachable seat top with upholstery	110	135	160	175	195

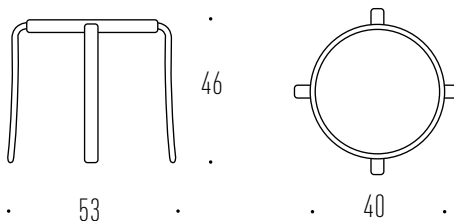

X-LINE SERIES

DESIGN: (1971) NIELS JØRGEN HAUGESEN

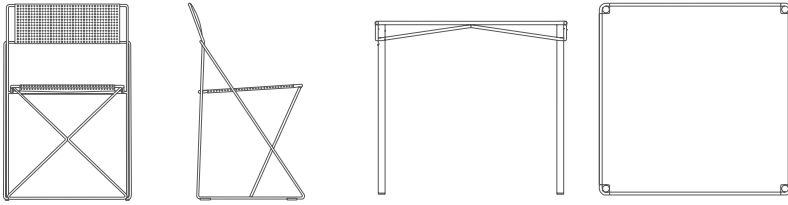

X-Line is an iconic chair designed by the Danish architect, Niels Jørgen Haugesen. The construction is based on a simple and logic design – where the iconic X plays the central part of the chair's function, strength and stability. The X-Line table is a natural extension and follows the minimalistic design line from the chair. Relaunched in 2022 in four powder-coat variants, which makes it particularly suitable for outdoor use.

STEEL COLOURS

See product details on the individual product pages



Bright chrome
Indoor use only

POWDER-COAT COLOURS



Black
Monochromatic
RAL5002
Indoor/
outdoor use



Off-White
Monochromatic
RAL9010
Indoor/
outdoor use



Brown
Monochromatic
RAL8011
Indoor/
outdoor use



Blue
Monochromatic
RAL5002
Indoor/
outdoor use

X-LINE CHAIR

DESIGN: (1977) NIELS JØRGEN HAUGESEN

SPECIFICATIONS & MEASUREMENTS

Description	Iconic stackable chair with the option of 4 lacquered versions suited for outdoor
Measurement	W50 x D45 x H77 x SH46 cm
Weight	Gross/Net: 5,5/5 kg/pc. 4 pcs/cart. 0,240 cbm/cart
Seat and back	Perforated steel
Stackable	Floor: 12 pcs. Trolley: 40 pcs.



X-LINE CHAIR

Item No.	Product	Price
MO 6100	Bright chrome - indoor use	440
MO 6100	Powder lacquer - indoor/outdoor use	440

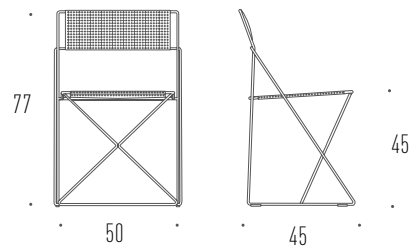

X-LINE TABLE

DESIGN: (1977) NIELS JØRGEN HAUGESEN

SPECIFICATIONS & MEASUREMENTS

Description	The light and simple design gives the table an industrial look. The lacquering makes it particularly suitable for outdoor environments.
Measurement	W80 x D80 x H72 cm
Weight	Gross/Net: 12/14 kg/pc. 1 pcs/cart. 0,145 cbm/cart
Table top	Powder lacquered steel
Frame	Steel tube, powder lacquered in the same colour as the table top



X-LINE TABLE

Item No.	Product	Price
MO 6151	Powder lacquer - indoor/outdoor use	1.375

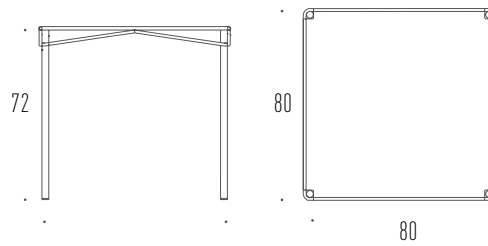

FREYA SERIES

DESIGN: SAYS WHO

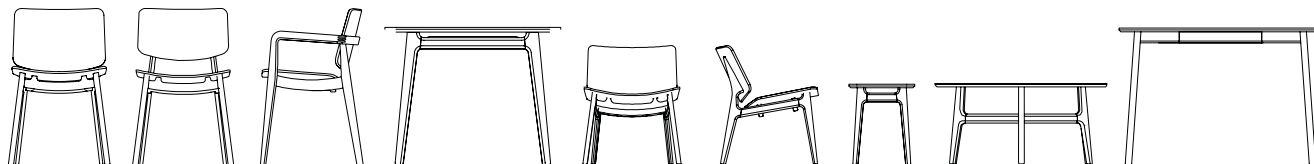

The popular Freya series consists of several furniture products. The design of the Freya series is rooted in classic Danish furniture design but interpreted for present standards. A modern wooden series with an astonishing abundance of understated details, highlighting the high degree of craftsmanship in the Freya series.

WOOD & TREATMENTS

See product details on the individual product pages



Oak, transparent lacquer
Oak, natural oil
Oak, white-oil
Oak, soap treatment
Oak, black-stained

LINOLEUM



Pebble 4175 NCS 3502-Y
Ash 4132 NCS 5502-G
Black 4023 NCS 9000-N

LAMINATE



Grey U1115 W Duopal NCS S4502-G
White F7949 Soft white Formica RAL 9016
Graphite F7837 Graphite Formica RAL8019
Wood pattern oak F 5374 Elegant oak Formica

RECOMMENDED FABRIC, LEATHER & ARTIFICIAL LEATHER

GROUP A	GROUP B	GROUP C	LEATHER 1	LEATHER 2
Valencia, Main Line Plus	Remix 3, Illusion	Atlas, Hallingdal 65	Hero, Sydney, Zea	Savanne, Dunes, Fauna

See the overview of fabric, leather and artificial leather on page 86

CERTIFICATIONS



EU Ecolabel certification on specific products:

Freya (4711)
Freya Armrest (4714)
Freya Lounge (4731)
Freya Lounge with seat and back upholstery (4711)

EU Ecolabel: DK/049/016

FREYA

DESIGN: (2016) SAYS WHO

SPECIFICATIONS & MEASUREMENTS

Description	The chair appears modern with its dynamic lines and elegant profile. It is a beautiful chair with great seating comfort.
Measurement	W50 x D50 x H79 x SH46 cm
Weight	Gross/Net: 7,5/7 kg/pc. 2 pcs/cart. 0,37 cbm/cart
Seat and back	Laminated plywood with oak veneer
Frame	Solid oak



FREYA

Item No.	Product	Without upholstery	A	B	C	1	2
MO 4711	Seat and back in oak	615					
MO 4711	Back in oak, seat upholstered		715	745	785	810	850
MO 4711	Fully upholstered seat and front side upholstered back		795	880	980	1.045	1.150

OPTIONS - ADDITIONAL PRICE

Item No.	Product	Price
	Frame, seat and back in black-stained oak	80
	Two buttons in front side upholstered back - same fabric as the back	120
	Two buttons in front side upholstered back in Savanne leather in selected colours	155

ACCESSORIES

Item No.	Product	Price
MO 1617	4 pcs. felt glides, white	20
MO 1638	4 pcs. teflon glides	20
MO 1639	2 built-in castors in front legs	185

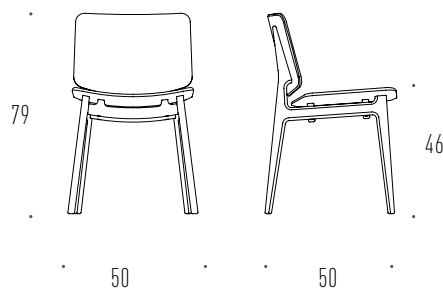

FREYA TWO

DESIGN: (2019) SAYS WHO

SPECIFICATIONS & MEASUREMENTS

Description	Elegant chair with a more narrow back. The Freya Two chair still looks modern with its dynamic alignment and same elegant profile as Freya chair.
Measurement	W50 x D50 x H79 x SH46 cm
Weight	Gross/Net: 7,5/7 kg/pc. 2 pcs/cart. 0,37 cbm/cart
Seat and back	Laminated plywood with oak veneer
Frame	Solid oak



FREYA TWO

Item No.	Product	Without Upholstery	A	B	C	1	2
MO 4710	Seat and back in oak	595					
MO 4710	Back in oak, seat upholstered		680	710	755	780	820
MO 4710	Fully upholstered seat and front side upholstered back		765	850	950	1.015	1.120

OPTIONS - ADDITIONAL PRICE

Item No.	Product	Price
	Frame, seat and back in black-stained oak	80
	Two buttons in front side upholstered back - same fabric as the back	120
	Two buttons in front side upholstered back in Savanne leather in selected colours	155

ACCESSORIES

Item No.	Product	Price
MO 1617	4 pcs. felt glides, white	20
MO 1638	4 pcs. teflon glides	20
MO 1639	2 built-in castors in front legs	185

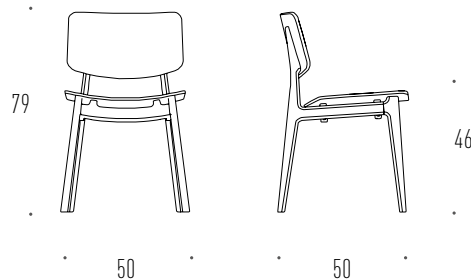

FREYA ARM

DESIGN: (2019) SAYS WHO

SPECIFICATIONS & MEASUREMENTS

Description	Elegant stackable chair with armrest for extra good seating comfort. The chair appears modern with its dynamic design and same profile as Freya and Freya Two.
Measurement	W60 x D58 x H79 x SH46 cm
Weight	Gross/Net: 10/8 kg/pc. 1 pcs/cart. 0,37 cbm/cart
Seat and back	Laminated plywood with oak veneer
Frame	Solid oak
Stackable	6 pcs. Measurement: B60 x D80 x H111 cm



FREYA ARM CHAIR

Item No.	Product	Without upholstery	A	B	C	1	2
MO 4714	Seat and back in oak	1.040					
MO 4714	Back in oak, seat upholstered		1.155	1.185	1.230	1.250	1.295
MO 4714	Fully upholstered seat and front side upholstered back		1.240	1.320	1.425	1.485	1.595

OPTIONS - ADDITIONAL PRICE

Item No.	Product	Prize
	Frame, seat and back in black-stained oak	80
	Two buttons in front side upholstered back - same fabric as the back	120
	Two buttons in front side upholstered back in Savanne leather in selected colours	155

ACCESSORIES

Item No.	Product	Prize
MO 1617	4 pcs. felt glides, white	20
MO 1638	4 pcs. teflon glides	20
MO 1639	2 built-in castors in front legs	185

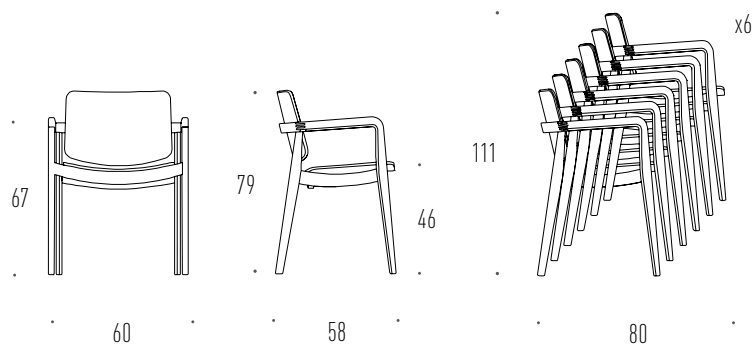

FREYA LOUNGE

DESIGN: (2017) SAYS WHO

SPECIFICATIONS & MEASUREMENTS

Description	Its lower height and wide seat combined with the lounge slope gives the chair great seating comfort.
Measurement	W60 x D62 x H72 x SH43 cm
Weight	Gross/Net: 11/9 kg/pc. 1pcs/cart. 0.35/ cbm/cart
Seat and back	Laminated plywood with oak veneer
Frame	Solid oak



FREYA LOUNGE

Item No.	Product	Without upholstery	A	B	C	1	2
MO 4731	Chair in oak	1.180					
MO 4731	Seat upholstered		1.285	1.335	1.405	1.445	1.515
MO 4731	Fully upholstered seat and front side upholstered back		1.400	1.500	1.625	1.700	1.825

OPTIONS - ADDITIONAL PRICE

Item No.	Product	Price
	Black-stained frame, seat and back	80
	Black-stained frame, back and upholstered seat	55
	1 stitching in the back	110

ACCESSORIES

Item No.	Product	Price
MO 1617	4 pcs. felt glides, white	20
MO 1638	4 pcs. teflon glides	20

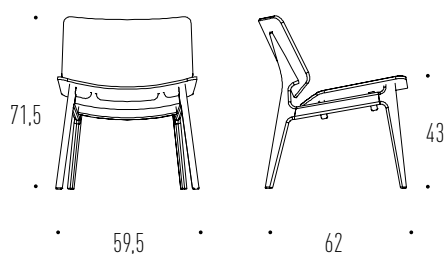

FREYA BENCH

DESIGN: (2019) SAYS WHO

SPECIFICATIONS & MEASUREMENTS

Description	Multi-purpose seating solution. An elegant supplement to any lounge area or alongside the dining table.
Measurement	W175 x D37,5 x H46 cm
Weight	Gross/Net: 1 pcs/cart. 0,35 cbm/cart
Seat	Wooden seat with beveled edge - oak veneer, surface treated, or with linoleum, or fully upholstered seat
Frame	Solid oak



FREYA BENCH

Item No.	Product	Without upholstery	A	B	C	1	2
MO 4740	Seat in oak	1.465					
MO 4740	Seat in oak with linoleum, edge laquered or soap treatment	1.600					
MO 4740	Upholstered seat		1.775	1.960	2.155	2.235	2.885

OPTIONS - ADDITIONAL PRICE

Item No.	Product	Price
	Black-stained oak	80

ACCESSORIES

Item No.	Product	Price
MO 1617	4 pcs. felt glides, white	20
MO 1638	4 pcs. teflon glides	20

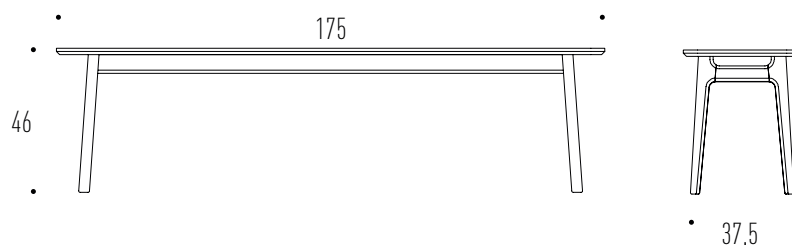

FREYA DESK

DESIGN: (2020) SAYS WHO

SPECIFICATIONS & MEASUREMENTS

Description	With its sleek shape and delicate size, the Freya desk is ideal for the workplace even in a small room.
Table height	74 cm
Table top thickness	25 mm
Table top	Oak veneer, or surface in linoleum or laminate. Bevelled edge in oak.
Frame and drawer	Solid oak



FREYA DESK

Item No.	Size	Product	Price
MO 4760-1	110 x 45 cm	Frame, drawer, and table top in solid oak	1.100
MO 4760-2	120 x 60	Frame, drawer, and table top in solid oak	1.355

OPTIONS - ADDITIONAL PRICE

Item No.	Product	Price
	Table top with surface in laminate or linoleum, edge laquered or soap treatment	115
	Frame and table top in black-stained solid oak	115
	Table edge, frame and top in black stain with linoleum surface	175



FREYA COFFEE TABLE

DESIGN: (2019) SAYS WHO

SPECIFICATIONS & MEASUREMENTS

Description	Rooted in classic Danish furniture design, the Freya Coffee Table series appears modern with its dynamic lines and clean profiles.
Table top thickness	25 mm
Table top	Beveled edge - the circular tables in solid oak, surface treated. The rectangular table in oak veneer with solid edge, surface treated. All tables are available with surface in linoleum or laminate with beveled edge in solid oak.
Frame	Solid oak



FREYA COFFEE TABLE

Item No.	Size	Product	Price
MO 4770-1	Ø40 x H50 cm	Solid oak	550
MO 4770-2	Ø60 x H45 cm	Solid oak	705
MO 4770-3	Ø85 x H45 cm	Solid oak	1.045
MO 4770-4	120 x 60 x H50 cm	Solid oak	1.045

OPTIONS - ADDITIONAL PRICE

Item No.	Product	Price
	Table top with surface in laminate or linoleum, edge laquered or soap treatment	115
	Frame and table top in black-stained solid oak	115
	Black stain of edge and frame of table with linoleum	175

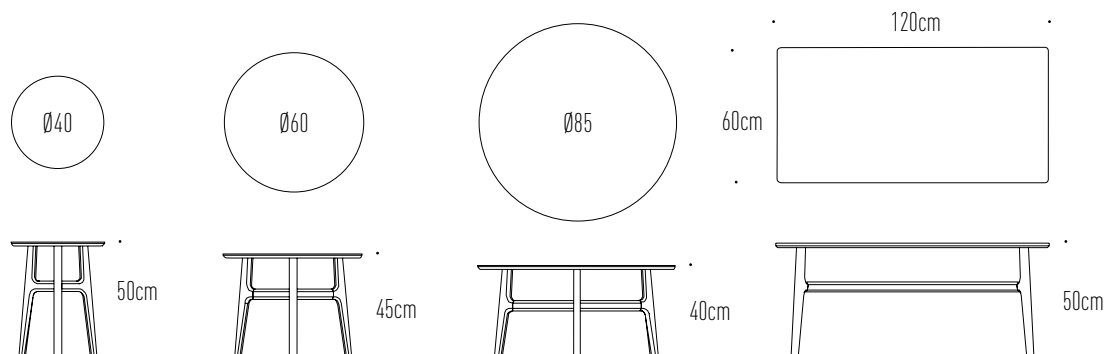

FREYA DINING TABLE

DESIGN: (2019) SAYS WHO

SPECIFICATIONS & MEASUREMENTS

Description	Modern table with synchronic extension mechanism that is easily expanded with a simple movement. The two extension leaves makes the table sit up to 12 people.
Table top thickness	25 mm
Table top	Beveled edge - solid wood, surface treated, or with linoleum or laminate
Extension leaf	Same treatment as the table top - also available in black MDF, lacquered
Frame	Solid wood



FREYA DINING TABLE

Item No.	Size	Product	Price
MO 4780	210 x 95 cm	Frame and table top in oak	2.995

FREYA DINING EXTENSION LEAF

Item No.	Size	Product	Price
MO 4789	95 x 48 cm	Extension leaf in solid oak	475
MO 4789	95 x 48 cm	Extension leaf with linoleum and oak edge	510
MO 4789	95 x 48 cm	Extension leaf in black MDF, lacquered	295
MO 4789	95 x 48 cm	Extension leaf in black-stained oak	500

OPTIONS - ADDITIONAL PRICE

Item No.	Product	Price
	Table top with surface in linoleum	155
	Frame and table top in black-stained oak	150
	Black stain of edge and frame of table with table top with surface in linoleum	175

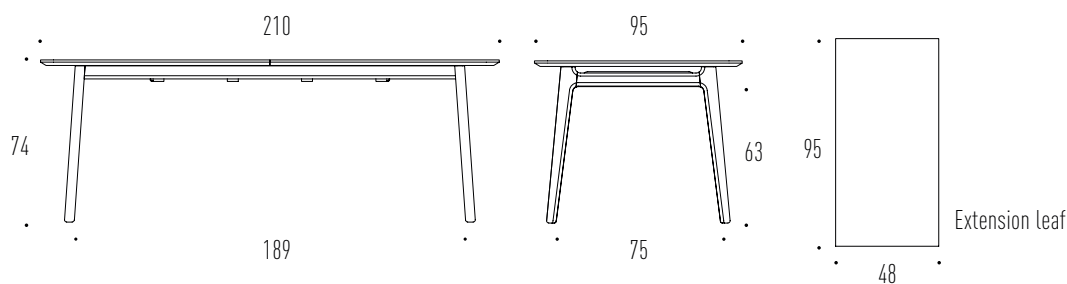

BUTTERFLY SERIES

DESIGN: NIELS GAMMELGAARD

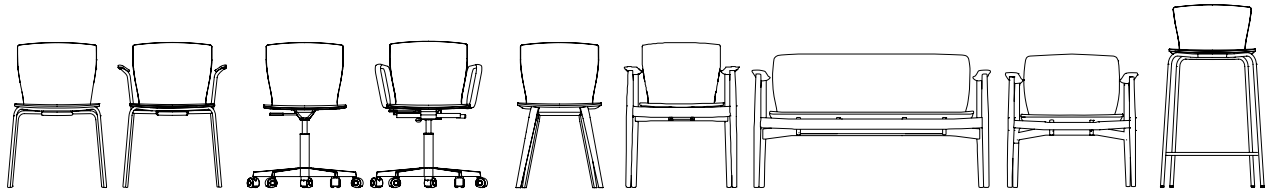

The Butterfly Series consists of 9 variants that offer a multitude of combinations with different kind of frames, wooden surfaces, and fabric variants. The chairs have a high seating comfort and elegant lightweight, yet distinctive and slim design. The seat shape and ease of the design resemble a butterfly, hence the name of these designer chairs.

WOOD & TREATMENTS

See product details on the individual product pages



Oak,
transparent
lacquer



Oak, black-
stained

STEEL & ALUMINUM COLOURS



Steel, bright
chrome



Steel, powder
lacquered in
matt, black
grained
lacquer



Polished
aluminium



Aluminium in
matt, black
grained lacquer

RECOMMENDED FABRIC, LEATHER & ARTIFICIAL LEATHER

GROUP A	GROUP B	GROUP C	LEATHER 1	LEATHER 2
Cura, Main Line Plus	Haku, Remix 3	Hallingdal 65	Sydney, Hero, Zea	Savanne, Zea, Triumph Crib

See the overview of fabric, leather and artificial leather on page 86

CERTIFICATIONS



EU Ecolabel: DK/049/016

EU Ecolabel certification on specific products:

Butterfly Bar Chair (5314 + 5315)
Butterfly Wood (5340)
Butterfly Classic Chair (5351)
Butterfly Classic Lounge (5369/5379)
Butterfly (5310)

BUTTERFLY WITH 4 STEEL LEGS

DESIGN: (2013) NIELS GAMMELGAARD

SPECIFICATIONS & MEASUREMENTS

Description	Stackable chair with lumbar support and flexibility in the back.
Measurement	W53 x D53 x H79 x SH46 cm
Weight	Gross/Net: 6/5 kg/pc. 4 pcs/cart. 0,375 cbm/cart
Seat and back	Laminated plywood with oak veneer or black-stained oak or upholstery, fully or partially
Frame	Tubular steel - bright chrome or powder lacquered in matt, black grained lacquer
Stackable	Without upholstery: Floor: 12 pcs. Trolley: 20 pcs. With upholstery: Floor: 10 pcs. Trolley: 12-15 pcs. W55 x D95 x H130 cm (with 12 pcs.)



BUTTERFLY WITH 4 STEEL LEGS

Item No.	Product	Without upholstery	A	B	C	1	2
MO 5310	Chair in oak	385					
MO 5310	Upholstered seat		505	545	590	615	690
MO 5310	Fully upholstered		660	745	855	890	1.090
MO 5310	Front side upholstered		695	785	905	975	1.150

OPTIONS - ADDITIONAL PRICE

Item No.	Product	Price
	Chair in black-stained oak	80
	Channel stitchings, fully upholstered model	205
	Channel stitchings, front side upholstered model	300

ACCESSORIES

Item No.	Product	Price
MO 1306	Hang-up bracket- single, in black plastic. Min. table length: 2 chairs 140 cm and 3 chairs 200 cm	45
MO 1154	Trolley - Chairs without upholstery: 20 pcs. Chairs with upholstery: 12-15 pcs.	1.855
MO 1213	Linking device - device: 9 cm	85
MO 1600	4 pcs. Loose, hard plastic glides, black (for soft floors)	20
MO 1601	4 pcs. Loose, less hard plastic glides, grey (for soft)	20
MO 1602	4 pcs. loose felt glides	20

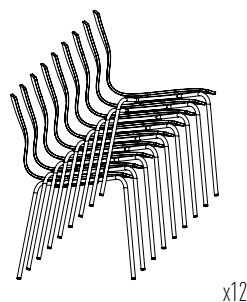
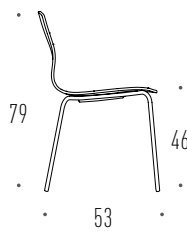
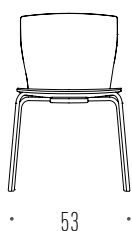

BUTTERFLY WITH 4 STEEL LEGS & ARMREST

DESIGN: (2013) NIELS GAMMELGAARD

SPECIFICATIONS & MEASUREMENTS

Description	Stackable chair with armrest and lumbar support and flexibility in the back.
Measurement	W53 x D53 x H79 x SH46 cm
Weight	Gross/Net: 6/5 kg/pc. 4 pcs/cart. 0,375 cbm/cart
Seat and back	Laminated plywood with oak veneer or black-stained or upholstery, fully or partially
Frame	Tubular steel: bright chrome or powder lacquered in matt, black grained lacquer Black PUR rubber - wooden armrests available at an additional price
Armrest	Without upholstery: Floor: 12 pcs. Trolley: 20 pcs.
Stackable	With upholstery: Floor: 10 pcs. Trolley: 12-15 pcs. Measurement with 12 pcs. W60 x D95 x H120 cm



BUTTERFLY WITH 4 STEEL LEGS AND ARMREST

Item No.	Product	Without upholstery	A	B	C	1	2
MO 5311	Chair in oak	495					
MO 5311	Upholstered seat		610	645	690	720	800
MO 5311	Fully upholstered		765	870	965	1.055	1.190
MO 5311	Front side upholstered		805	890	845	1.090	1.265

OPTIONS - ADDITIONAL PRICE

Item No.	Product	Price
	Chair in black-stained oak	80
	Armrest in wood, laquered or black-stained	45
	Channel stitchings, fully upholstered model	205
	Channel stitchings, front side upholstered model	300

ACCESSORIES

Item No.	Product	Price
MO 1306	Hang-up bracket- single, in black plastic. Min. table length: 2 chairs 140 cm and 3 chairs 200 cm	45
MO 1154	Trolley - Chairs without upholstery: 20 pcs. Chairs with upholstery: 10 pcs.	1.855
MO 1213	Linking device - device: 9 cm	85
MO 1600	4 pcs. Loose, hard plastic glides, black (for soft floors)	20
MO 1601	4 pcs. Loose, less hard plastic glides, grey (for soft)	20
MO 1602	4 pcs. loose felt glides	20

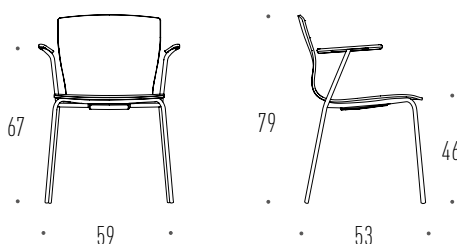

BUTTERFLY SWIVEL

DESIGN: NIELS GAMMELGAARD

SPECIFICATIONS & MEASUREMENTS

Description	Functional office chair without compromising on design.
Measurement	W64 x D55 x H77-95 x SH44-58 cm
Weight	Gross/Net: 13,9/11,9 kg/pc. 2 pcs/cart. 0,43 kbm kart.
Seat and back	Laminated plywood with oak veneer with upholstery
Frame	Polished aluminium and aluminium in matt, black grained lacquer
Model MO 5480	Castors, flexible tilt, height adjustment
Model MO 5482	Glides, flexible tilt, revolving, self centering
Model MO 5484	Glides, flexible tilt, height adjustment



BUTTERFLY SWIVEL

Item No.	Product	A	B	C	1	2
MO 5480, 5482, 5484	Fully upholstered	830	925	1.035	1.105	1.265
MO 5480, 5482, 5484	Front side upholstered	875	970	1.090	1.165	1.335

OPTIONS - ADDITIONAL PRICE

Item No.	Product	Price
	Glides with felt	35
	Hard castors	35
	Frame and armrest in black, grained lacquer	60
	Narrow channel stitchings, fully upholstered version	205
	Narrow channel stitchings, front side upholstered version	300

ACCESSORIES

Item No.	Product	Price
MO 1306	Hang-up bracket- single, in black plastic. Min. table length: 2 chairs 140 cm and 3 chairs 200 cm	55
MO 1507	Writing tablet - tablet in plywood with white laminat, edge painted black. Steel arm in black lacquer. Rotateable, fixed on column	375
MO 1608	1 set (5 pcs.) plastic glides, hard (for soft floors)	110
MO 1609	1 set (5 pcs.) plastic glides with felt (for hard floors)	110
MO 1611	1 set (5 pcs.) soft castors (for hard floors)	110
MO 1622	1 set (5 pcs.) hard castors (for soft floors)	110

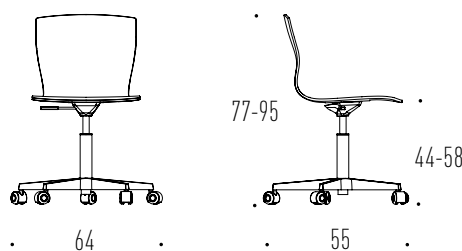

BUTTERFLY SWIVEL WITH ARMREST

DESIGN: (2013) NIELS GAMMELGAARD

SPECIFICATIONS & MEASUREMENTS

Description	Functional office chair without compromising on design.
Measurement	W64 x D55 x H77-95 x SH44-58 cm
Weight	Gross/Net: 13,9/11,9 kg/pc. 1 pcs/cart. 0,35 kbm kart.
Seat and back	Laminated plywood with oak veneer with upholstery
Frame and armrests	Polished aluminium and aluminium in matt, black grained lacquer
Model MO 5481	Castors, flexible tilt, height adjustment
Model MO 5483	Glides, flexible tilt, revolving, self centering
Model MO 5485	Glides, flexible tilt, height adjustment



BUTTERFLY SWIVEL WITH ARMREST

Item No.	Product	A	B	C	1	2
MO 5481, 5483, 5485	Fully upholstered	1.090	1.190	1.300	1.375	1.545
MO 5481, 5483, 5485	Front side upholstered	1.135	1.235	1.360	1.430	1.610

OPTIONS - ADDITIONAL PRICE

Item No.	Product	Price
	Glides with felt	35
	Hard castors	35
	Frame and armrest in black, grained lacquer	60
	Narrow channel stitchings, fully upholstered version	205
	Narrow channel stitchings, front side upholstered version	300

ACCESSORIES

Item No.	Product	Price
MO 1608	1 set (5 pcs.) plastic glides, hard (for soft floors)	110
MO 1609	1 set (5 pcs.) plastic glides with felt (for hard floors)	110
MO 1611	1 set (5 pcs.) soft castors (for hard floors)	110
MO 1622	1 set (5 pcs.) hard castors (for soft floors)	110

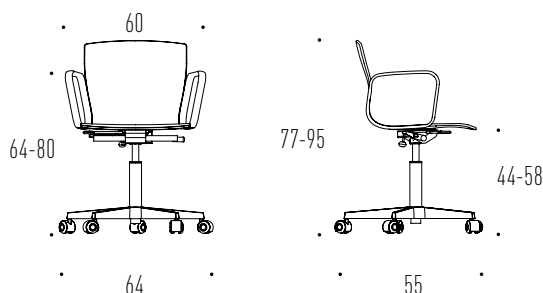

BUTTERFLY SWIVEL HIGH

DESIGN: (2016) NIELS GAMMELGAARD

SPECIFICATIONS & MEASUREMENTS

Description	Functional office chair without compromising on design.
Measurement	W64 x D55 x H85-103 x SH44-58 cm
Weight	Gross/Net: 13,5/11,5 kg/pc. 2 pcs/cart. 0,43 cbm/cart
Seat and back	Laminated plywood with oak veneer with upholstery
Frame	Polished aluminium and aluminium in matt, black grained lacquer
Model MO 5490	Castors, flexible tilt, height adjustment
Model MO 5492	Glides, flexible tilt, revolving, self centering
Model MO 5494	Glides, flexible tilt, height adjustment



BUTTERFLY SWIVEL HIGH

Item No.	Product	A	B	C	1	2
MO 5490, 5492, 5494	Fully upholstered	960	1.060	1.195	1.285	1.550
MO 5490, 5492, 5495	Front side upholstered	1.010	1.120	1.265	1.345	1.625

OPTIONS - ADDITIONAL PRICE

Item No.	Product	Price
	Glides with felt	35
	Hard castors	35
	Frame and armrest in black, grained lacquer	60
	Wide channel stitchings, fully upholstered version	205
	Wide channel stitchings, front side upholstered version	300

ACCESSORIES

Item No.	Product	Price
MO 1306	Hang-up bracket- single, in black plastic. Min. table length: 2 chairs 140 cm and 3 chairs 200 cm	55
MO 1507	Writing tablet - tablet in plywood with white laminat, edge painted black. Steel arm in black lacquer. Rotateable, fixed on column	375
MO 1608	1 set (5 pcs.) plastic glides, hard (for soft floors)	110
MO 1609	1 set (5 pcs.) plastic glides with felt (for hard floors)	110
MO 1611	1 set (5 pcs.) soft castors (for hard floors)	110
MO 1622	1 set (5 pcs.) hard castors (for soft floors)	110

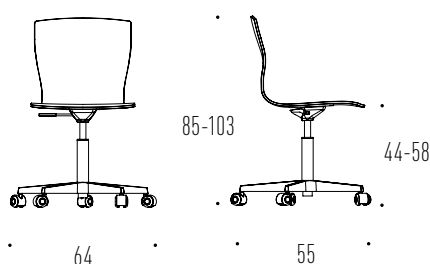

BUTTERFLY SWIVEL HIGH WITH ARM

DESIGN: (2016) NIELS GAMMELGAARD

SPECIFICATIONS & MEASUREMENTS

Description	Functional office chair without compromising on design.
Measurement	W64 x D55 x H85-103 x SH44-58 cm
Weight	Gross/Net: 14,1/12,1 kg/pc. 1 pcs/cart. 0,35 cbm/cart
Seat and back	Laminated plywood with oak veneer with upholstery
Frame and armrests	Polished aluminium and aluminium in matt, black grained lacquer
Model MO 5491	Castors, flexible tilt, height adjustment
Model MO 5493	Glides, flexible tilt, revolving, self centering
Model MO 5495	Glides, flexible tilt, height adjustment



BUTTERFLY SWIVEL HIGH WITH ARMREST

Item No.	Product	A	B	C	1	2
MO 5491, 5493, 5495	Fully upholstered	1.220	1.330	1.460	1.540	1.810
MO 5491, 5493, 5495	Front side upholstered	1.270	1.390	1.520	1.610	1.895

OPTIONS - ADDITIONAL PRICE

Item No.	Product	Price
	Glides with felt	35
	Hard castors	35
	Frame and armrest in black, grained lacquer	60
	Wide channel stitchings, fully upholstered version	205
	Wide channel stitchings, front side upholstered version	300

ACCESSORIES

Item No.	Product	Price
MO 1608	1 set (5 pcs.) plastic glides, hard (for soft floors)	110
MO 1609	1 set (5 pcs.) plastic glides with felt (for hard floors)	110
MO 1611	1 set (5 pcs.) soft castors (for hard floors)	110
MO 1622	1 set (5 pcs.) hard castors (for soft floors)	110

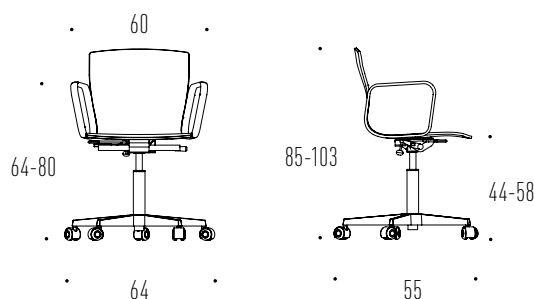

BUTTERFLY WOOD

DESIGN: (2013) NIELS GAMMELGAARD

SPECIFICATIONS & MEASUREMENTS

Description	Chair in Nordic design tradition with laminated wood shell and wood frame in Scandinavian oak.
Measurement	W46 x D52 x H79 x SH46 cm
Weight	Gross/Net: 5,4/4,9 kg/pc. 2 pcs/cart. 0,32 cbm/cart
Seat and back	Laminated plywood with oak veneer with transparent lacquer or black-stained or upholstery, fully or partially
Frame	Laminated wood with top veneer in oak with transparent lacquer or black-stained



BUTTERFLY WOOD

Item No.	Product	Without Upholstery	A	B	C	1	2
MO 5340	Chair in oak	445					
MO 5340	Upholstered seat		580	610	645	670	705
MO 5340	Fully upholstered		705	780	865	920	1.015
MO 5340	Front side upholstered		745	820	910	970	1.065

OPTIONS - ADDITIONAL PRICE

Item No.	Product	Price
	Chair in black-stained oak	80
	Frame in black-stained oak	55
	Narrow channel stitchings, fully upholstered version	205
	Narrow channel stitchings, front side upholstered version	300

ACCESSORIES

Item No.	Product	Price
MO 1306	Hang-up bracket- single, in black plastic. Min. table length: 2 chairs 140 cm and 3 chairs 200 cm	45
MO 1612	4 pcs. loose felt glides, white	20
MO 1613	4 pcs. loose plastic glides, white	20

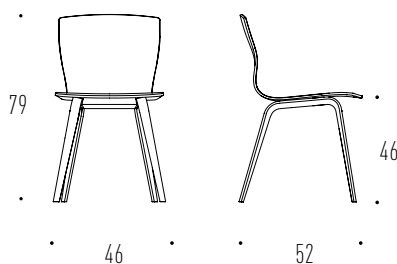

BUTTERFLY CLASSIC ARMCHAIR

DESIGN: (2018) NIELS GAMMELGAARD

SPECIFICATIONS & MEASUREMENTS

- Description** Exclusive and comfortable solution for dining tables as well as meeting tables, but also functions as an independent chair in classic design surroundings.
- Measurement** W63 x D52 x H80 x SH46 cm
- Weight** Gross/Net: 6,5/4,9 kg/pc. 1 pcs/cart. 0,33 cbm/cart
- Seat and back** Laminated plywood with oak veneer or black-stained or upholstery, fully or partially
- Frame and armrest** Solid wood with transparent lacquer or black-stained oak.



BUTTERFLY CLASSIC ARMCHAIR

Item No.	Product	Without upholstery	A	B	C	1	2
MO 5351	Chair in oak	700					
MO 5351	Fully upholstered		980	1.070	1.175	1.245	1.465
MO 5351	Front side upholstered		1.010	1.075	1.220	1.295	1.485

OPTIONS - ADDITIONAL PRICE

Item No.	Product	Price
	Chair in black-stained oak	80
	Frame and armrest in black-stained oak	55

ACCESSORIES

Item No.	Product	Price
MO 1617	4 pcs. felt glides, white	20
MO 1638	4 pcs. teflon glides	20
MO 1640	2 pcs. front castors	190

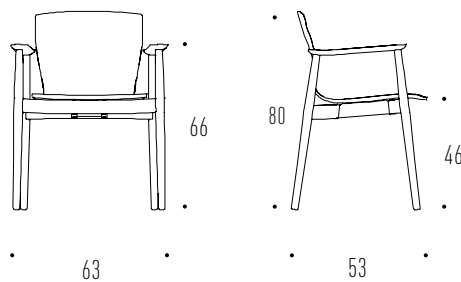

BUTTERFLY CLASSIC LOUNGE

DESIGN: (2018) NIELS GAMMELGAARD

SPECIFICATIONS & MEASUREMENTS

Description	The low height and the wide seat render the chair with exceptional comfort combined with the simple, beautiful design.
Measurement	W73 x D63 x H73/75 x SH39/43 cm
Weight	Gross/Net: 16/14 kg/pc. 1 pcs/cart. 0,45 cbm/cart
Model MO 5369	Seat height: H73 x SH39 cm
Model MO 5379	Seat height: H75 x SH43 cm
Seat and back	Laminated plywood with oak veneer or black-stained or upholstery, fully or partially
Frame and armrest	Solid wood with transparent lacquer or black-stained oak



BUTTERFLY CLASSIC LOUNGE

Item No.	Product	Without upholstery	A	B	C	1	2
MO 5369, MO 5379	Chair in oak	1.530					
MO 5369, MO 5379	Fully upholstered		1.820	1.995	2.215	2.350	2.575
MO 5369, MO 5379	Front side upholstered		1.910	2.095	2.325	2.470	2.705

OPTIONS - ADDITIONAL PRICE

Item No.	Product	Price
	Chair in black-stained oak	80
	Frame and armrest in black-stained oak	55

ACCESSORIES

Item No.	Product	Price
MO 1617	4 pcs. felt glides, white	20
MO 1638	4 pcs. teflon glides	20

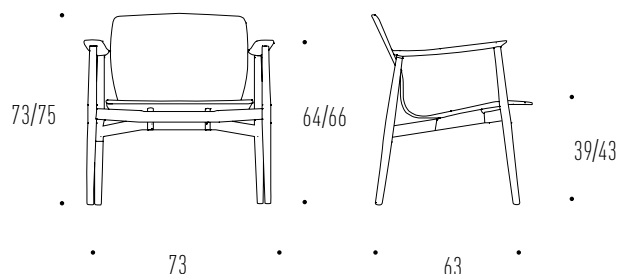

BUTTERFLY CLASSIC 2-SEATER

DESIGN: (2018) NIELS GAMMELGAARD

SPECIFICATIONS & MEASUREMENTS

Description	A lounge 2-seater in a simple and slim design expression with extraordinary seating comfort.
Measurement	B131 x D63 x H73/75 x SH39/43 cm
Weight	Gross/Net: 20/18 kg/pc. 1 pcs/cart. 0,75 cbm/cart
Model MO 5381	Seat height: H73 x SH39 cm
Model MO 5391	Seat height: H75 x SH43 cm
Seat and back	Laminated plywood with fully upholstery
Frame and armrest	Solid wood with transparent lacquer or black-stained oak



BUTTERFLY CLASSIC 2-SEATER

Item No.	Product	A	B	C	1	2
MO 5381, MO 5391	Fully upholstered	3.395	3.625	3.905	4.080	4.360

OPTIONS - ADDITIONAL PRICE

Item No.	Product	Price
	Frame in black-stained oak	115

ACCESSORIES

Item No.	Product	Price
MO 1617	4 pcs. felt glides, white	20
MO 1638	4 pcs. teflon glides	20

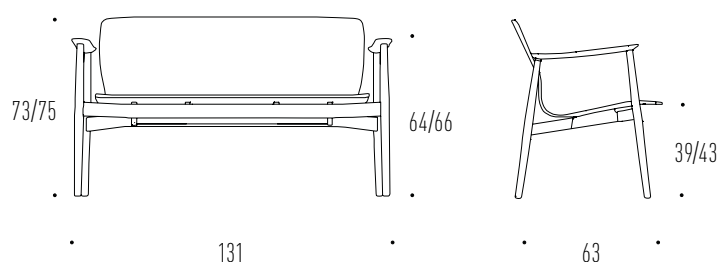

BUTTERFLY BAR

DESIGN: (2013) NIELS GAMMELGAARD

SPECIFICATIONS & MEASUREMENTS

Description	Stackable bar chair with lumbar support and flexibility in the back.
Measurement	W49 x D53 x H87/99 x SH65/77cm
Weight	Gross/Net: 6/5 kg/pc. 2 pcs/cart. 0,29 cbm/cart
Seat height	MO 5318: H87 x SH65 cm MO 5319: H99 x SH77 cm
Seat and back	Laminated plywood with oak veneer or black-stained or upholstery, fully or partially
Frame	Tubular steel - bright chrome or powder lacquered in matt, black grained lacquer
Stackable	6 pcs.



BUTTERFLY BAR

Item No.	Product	Without upholstery	A	B	C	1	2
MO 5318, MO 5319	Chair in oak	510					
MO 5318, MO 5319	Fully upholstered		805	895	1.005	1.075	1.190
MO 5318, MO 5319	Front side upholstered		850	940	1.055	1.130	1.135

OPTIONS - ADDITIONAL PRICE

Item No.	Product	Price
	Chair in black-stained oak	100

ACCESSORIES

Item No.	Product	Price
MO 1600	4 pcs. Loose, hard plastic glides, black (for soft floors)	20
MO 1601	4 pcs. Loose, less hard plastic glides, grey (for soft)	20
MO 1602	4 pcs. loose felt glides	20
MO 1306	Hang-up bracket- single, in black plastic.	55

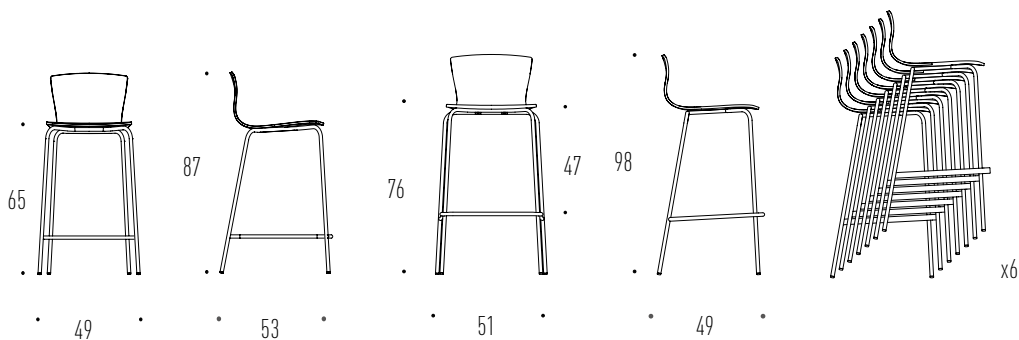

MODEL 107 SERIES

DESIGN: (1950) IB KOFOD-LARSEN

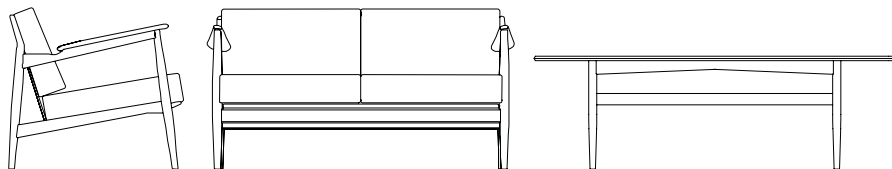

Model 107 was designed in the 1950s and originally produced by Magnus Olesen in 1956. Paying respect to the original design and craftsmanship, the series is being relaunched in a classic version in oak, teak, leather and wool. The design is refreshed by additional coloured option in grey speaking to the modern design lover.

WOOD & TREATMENTS

See product details on the individual product pages

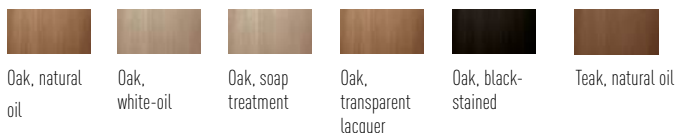

Oak, natural oil

Oak, white-oil

Oak, soap treatment

Oak, transparent lacquer

Oak, black-stained

Teak, natural oil

PAINTED BEECH



Beech, painted grey
NCS S3000-N

RECOMMENDED FABRIC, LEATHER & ARTIFICIAL LEATHER

GROUP A	GROUP B	GROUP C	LEATHER 1	LEATHER 2
	Main Line Flax, Synergy, Remix 3	Hallingdal 65,	Hero, Sydney, Zea	Savanne, Dunes, Vacona

See the overview of fabric, leather and artificial leather on page 86

MODEL 107 LOUNGE CHAIR

DESIGN: (1950) IB KOFOD-LARSEN

SPECIFICATIONS & MEASUREMENTS

Description A comfortable lounge chair designed in the 50s - with details that reflect the original, classic design from the Danish Modern era.

Measurement W71 x D74 x H68 x SH40 cm

Weight Gross/Net: 19/18 kg/pc. 1 pcs/cart. 0,590 cbm/cart

Cushions Fully upholstered reversible cushions for seat and back

Frame and armrest Solid oak, teak or painted beech



MODEL 107

Item No.	Product	A	B	C	1	2
MO 107	Frame and armrest in painted beech (Grey)	2.030	2.245	2.505	2.665	2.925
MO 107	Frame and armrest in oak	2.435	2.655	2.910	3.070	3.330
MO 107	Frame in oak and armrest in oiled teak	2.740	2.955	3.215	3.375	3.635
MO 107	Frame and armrest in oiled teak	4.470	4.685	4.940	5.100	5.365

OPTIONS - ADDITIONAL PRICE

Item No.	Product	Price
	6 buttons in the back - same fabric as the chair	155
	6 buttons in the back selected colours in Savanne leather	215

ACCESSORIES

Item No.	Product	Price
MO 1617	4 pcs. Felt glides, white	20
MO 1638	4 pcs. Teflon glides	20

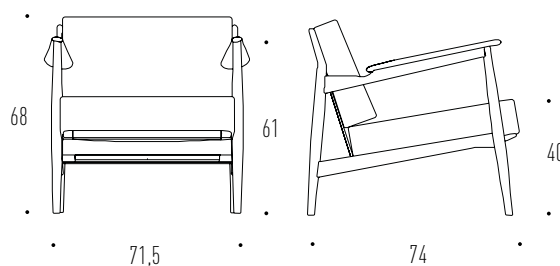

MODEL 107 2-SEATER

DESIGN: (1950) IB KOFOD-LARSEN

SPECIFICATIONS & MEASUREMENTS

Description A comfortable lounge 2-seater designed in the 50s - with details that reflect the original, classic design from the Danish Modern era.

Measurement W131 x D74 x H68 x SH40 cm

Weight Gross/Net: 37/36 kg/pc. 1 pcs/cart. 1,180 cbm/cart

Cushions Fully upholstered reversible cushions for seat and back

Frame and armrest Solid oak, teak or painted beech



MODEL 107S

Item No.	Product	A	B	C	1	2
MO 107S	Frame and armrest in oak	4.125	4.555	5.070	5.390	5.915
MO 107S	Frame in oak and armrest in oiled teak	4.425	4.860	5.375	5.695	6.120
MO 107S	Frame and armrest in oiled teak	10.380	11.850	11.315	11.640	12.160

OPTIONS - ADDITIONAL PRICE

Item No.	Product	Price
	12 buttons in the back - same fabric as the chair	305
	12 buttons in the back selected colours in Savanne leather	430

ACCESSORIES

Item No.	Product	Price
MO 1617	4 pcs. Felt glides, white	20
MO 1638	4 pcs. Teflon glides	20

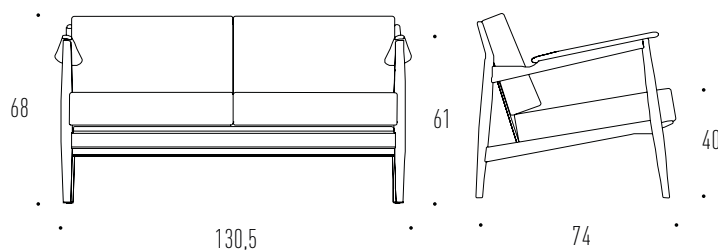

MODEL 107 COFFEE TABLE

DESIGN: (1950) IB KOFOD-LARSEN

SPECIFICATIONS & MEASUREMENTS

Description	Designed in the 50s in the same style as the rest of the Model 107 series.
Measurement	W120 x D56 x H50 cm
Table top	Surface in oak or teak with solid edge in oak or teak
Frame	Solid oak



MODEL 107T

Item No.	Product	Price
M0107T-L2	Frame in oak (oiled, white-oiled, or soap treated oak) and table top in oak veneer with solid oak edge (same treatment as frame)	1.970
M0107T-L1	Frame in oak (white-oiled) and table top in teak veneer with solid teak edge, oiled	2.070
M0107T-L4	Frame in oak (black-stained) and table top in teak veneer with solid teak edge, oiled	2.080
M0107T-L5	Frame in oak (oiled) and table top in teak veneer with solid teak edge, oiled	2.070

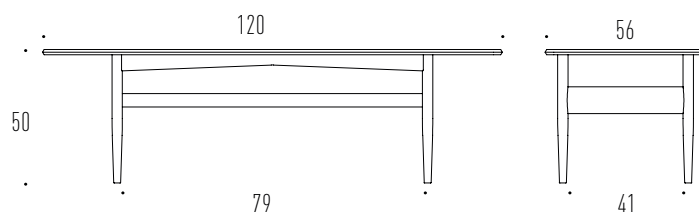

Ø CHAIR

DESIGN: (2020) ØIVIND SLAATTO



A chair in modular design consisting of three parts - seat, back and frame - elegantly combined with just one screw. This makes the chair easy to disassemble, so parts can be recycled and reused. The chair is created under the aspect of unique design, longevity and minimal transport costs due to the chairs stacking ability.

WOOD & TREATMENTS

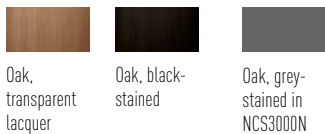

Oak, transparent lacquer

Oak, black-stained

Oak, grey-stained in NCS3000N

SPECIAL COLOURS ON SEAT AND BACK IN OAK

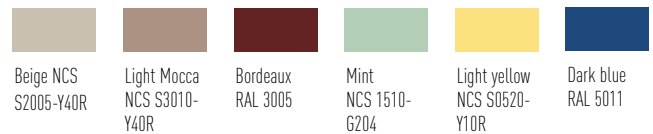

Beige NCS S2005-Y40R

Light Mocca NCS S3010-Y40R

Bordeaux RAL 3005

Mint NCS 1510-G204

Light yellow NCS S0520-Y10R

Dark blue RAL 5011

STANDARD STEEL COLOURS

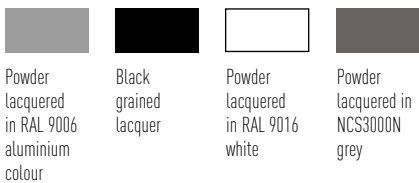

Powder lacquered in RAL 9006 aluminium colour

Black grained lacquer

Powder lacquered in RAL 9016 white

Powder lacquered in NCS3000N grey

SPECIAL STEEL COLOURS



Beige NCS S2005-Y40R

Light Mocca NCS S3010-Y40R

Bordeaux RAL 3005

Mint NCS 1510-G204

STANDARD SCREW COLOURS

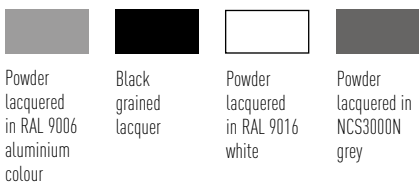

Powder lacquered in RAL 9006 aluminium colour

Black grained lacquer

Powder lacquered in RAL 9016 white

Powder lacquered in NCS3000N grey

SPECIAL SCREW COLOURS

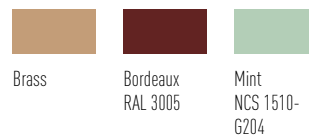

Brass

Bordeaux RAL 3005

Mint NCS 1510-G204

RECOMMENDED FABRIC, LEATHER & ARTIFICIAL LEATHER

GROUP A	GROUP B	GROUP C	LEATHER 1	LEATHER 2
Cura, Era	Remix 3, Main Line Flax, Illusion	Atlas, Hallingdal 65	Hero, Sydney, Zea	Savanne, Vacona, Fauna

See the overview of fabric, leather and artificial leather on page 89

Ø CHAIR - 9 SELECTED VARIANTS

DESIGN: (2020) ØIVIND SLAATTO



Ø CHAIR - 9 SELECTED VARIANTS

Item No.	Product	Description	Price
MO 2030-L1	CLASSIC - Wood/ White/ Grey	Frame: White. Seat: Oak w/transparent lacquer. Screw: Brass. Back: Grey	445
MO 2030-L2	CLASSIC - Black Monochrome	Frame: Black grained lacquer. Seat: Oak, painted black. Screw: Black. Back: Oak, painted black	455
MO 2030-L3	CLASSIC - Wood/ Wood/ White	Frame: White. Seat: Oak w/transparent lacquer. Screw: White. Back: Oak w/transparent lacquer	455
MO 2030-L4	NATURE - Nature/ Leather	Frame: Beige. Seat: Upholstered in leather - Royal Nubuck Ecu 30253. Screw: Brass. Back: Light Mocca	745
MO 2030-L5	NATURE - Nature	Frame: Mocca. Seat: Light. Mocca. Screw: Brass. Back: Beige	555
MO 2030-L6	COLOURS - Cool Mint	Frame: Bordeaux. Seat: Mint. Screw: Brass. Back: Dark blue	555
MO 2030-L7	COLOURS - Cool Mint Fabric	Frame: Mint. Seat: Upholstered - Atlas 911. Screw: Mint. Back: Oak w/transparent lacquer	600
MO 2030-L8	COLOURS - Bordeaux Pang	Frame: Bordeaux. Seat: Upholstered - Atlas 661. Screw: Bordeaux. Back: Bordeaux	615
MO 2030-L9	COLOURS - Pale Sun	Frame: Grey. Seat: Light yellow. Screw: Grey. Back: Oak w/transparent lacquer	455

Ø CHAIR

DESIGN: (2020) ØIVIND SLAATTO

SPECIFICATIONS & MEASUREMENTS

Description	A chair in a modular design with only 3 elements - back, seat and legs - assembled elegantly with one screw.
Measurement	W50 x D53 x H80 x SH45 cm
Weight	Gross/Net: 5,7/4,6 kg/pc. 5 pcs/cart. 0,375 cbm/cart
Stackable	Without upholstery: On the floor: 12 pcs. On the trolley: 20 pcs. With upholstery: On the trolley: 12-14 pcs.



Ø CHAIR

Item No.	Product	Without upholstery	A	B	C	1	2
MO 2030	Chair in oak with transparent lacquer	445					
MO 2030	Seat upholstered - with visible screw		530	595	680	290	815

OPTIONS - ADDITIONAL PRICE

Item No.	Product	Price
	Frame colour - see page 37	20
	Seat screw colour - see page 37	20
	Seat and back colour - see page 37	20

*Option for the selected special colours - when purchasing a minimum of 25 pcs. in the same color

ACCESSORIES

Item nr.	Product	Price
	Plastic glides in black, white, grey or beige	25
MO 1214	Linking device bright chrome	80
MO 1154	Trolley - min. 20 pcs. with wooden seat. Upholstered chairs: 12-14 pcs.	1.855

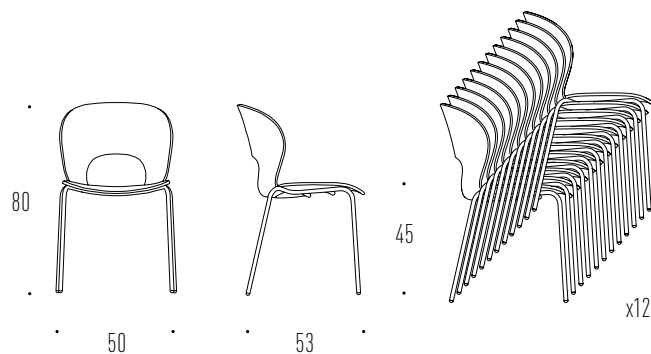

PAUSE

DESIGN: BUSK + HERTZOG

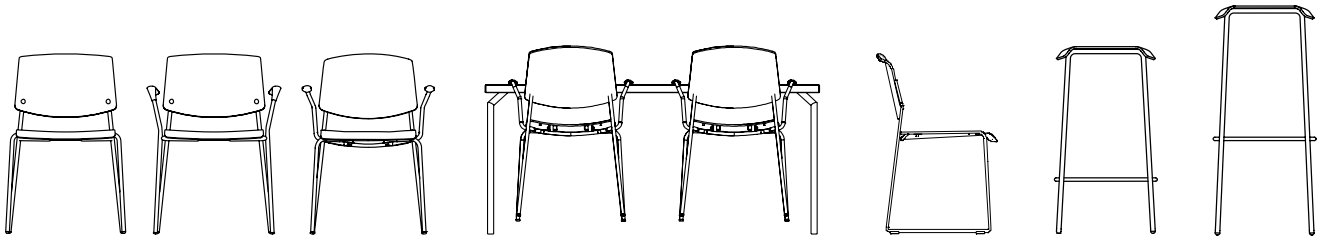

The Pause chair is designed to appear just as beautiful from the front as from behind. The expression is simple and light – like the chair that is easily stacked or put in rows. Available with or without arm rests pointing backwards or forward. Pause Bar Stool is also light and modern. The Pause chair series is also available with seat and back in a composite materiale.

WOOD & TREATMENTS



Oak,
transparent
lacquer

Oak, black-
stained

COMPOSITE COLOURS

See product details on the individual product pages



Brown grey
NCS S5005-
Y50R

Beige
NCS S2005-
Y30R

Black
NCS S9000-N

STEEL COLOURS



Tubular steel:
powder lacquer
in black, matt
grained lacquer

Tubular steel:
Bright chrome

LINOLEUM



Pebble
4175
NCS 3502-Y

Ash
4132
NCS 5502-G

Black
4023
NCS 9000-N

LAMINATE



Grey
U1115 W
Duropal
NCS S4502-G

White
F7949 Soft
white Formica
RAL 9016

Graphite
F7837 Graphite
Formica
RAL8019

Wood pattern oak
F 5374 Elegant oak
Formica

RECOMMENDED FABRIC, LEATHER & ARTIFICIAL LEATHER

GROUP A	GROUP B	GROUP C	LEATHER 1	LEATHER 2
Cura, Mainline Plus	Fame, Haku, Illusion, Remix 3	Hallingdal 65	Hero, Sydney, Zea	Savanne, Fauna

See the overview of fabric, leather and artificial leather on page 86

CERTIFICATIONS



EU Ecolabel certification on specific products:

- Pause with wood shell (866134)
- Pause with seat and back upholstery (8661)
- Pause Runner with seat and back in veneer (8640)
- Pause Runner with seat and back upholstery (8640)

EU Ecolabel: DK/049/016

PAUSE

DESIGN: (2005) BUSK + HERTZOG

SPECIFICATIONS & MEASUREMENTS

Description	Simple and light chair that can be easily stacked or lined up in rows.
Measurement	W53 x D53 x H80 x SH45 cm
Weight	Without upholstery: Gross/Net: 5,7/4,6 kg/pc. 5 pcs/cart. 0,395 cbm/cart With upholstery: Gross/Net: 5,7/4,6 kg/pc. 4 pcs/cart. 0,395 cbm/cart
Seat and back	Laminated plywood with laminate or linoleum, composite or oak veneer and fully or partially upholstered
Frame	Tubular steel
Stackable	Without upholstery: Floor: 10 pcs. Trolley 20 pcs. With upholstery: Floor: 8 pcs. Trolley 12 pcs.



PAUSE

Item No.	Product	Without upholstery	A	B	C	1	2
MO 8661	Seat and back in plywood with laminate or linoleum	355					
MO 8661	Seat and back in plywood with oak veneer	385					
MO 8661	Seat and back in black composite	305					
MO 8661	Seat and back in beige or brown-grey composite	375					
MO 8661	Back in laminate/linoleum/composite and seat upholstered		430	460	500	525	590
MO 8661	Seat and back fully upholstered		460	530	625	685	780

OPTIONS - ADDITIONAL PRICE

Item No.	Product	Price
	Seat and back in black-stained oak	80
	Black screws in the back when the frame is black	25

ACCESSORIES

Item No.	Product	Price
MO 1387	Single hang-up bracket - two rods in bright chromed steel. Mini. Table length: 2 stole 140 cm/3 stole 200 cm. Min. table length: Mix table 80 cm, Brunch table 90 cm	75
MO 1201	Linking device - 1 set in black plastic - distance between the legs of the chairs: 1 cm	50
MO 1186	Trolley, painted black	1.350
MO 1501	Writing tablet, removable, white compact laminate with black core. Tubular steel in bright chrome	275
MO 1600	4 pcs loose hard glides, black, for soft floors	20
MO 1601	4 pcs. loose, less hard plastic glides, dark grey (for hard floors)	20
MO 1602	4 pcs. felt glides	20
MO 1834-1	1 set composite seat and back, black + screws	195
MO 1834-2	1 set composite seat and back, beige/brown-grey + screws	260

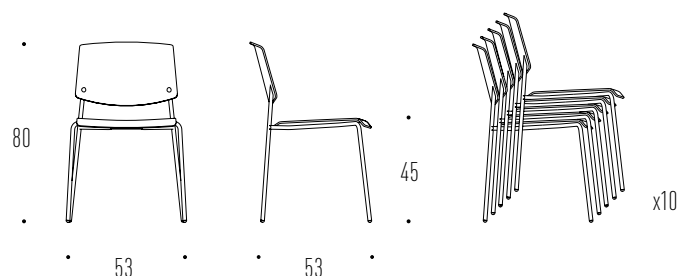

PAUSE WITH ARMREST

DESIGN: (2005) BUSK + HERTZOG

SPECIFICATIONS & MEASUREMENTS

Description	Simple and light stackable chair with armrests pointing backwards.
Measurement	W62 x D53 x H80 x SH45 cm
Weight	Without upholstery: Gross/Net: 8,8/7,7 kg/pc. 5 pcs/cart. 0,53 cbm/cart With upholstery: Gross/Net: 8,8/7,7 kg/pc. 4 pcs/cart. 0,53 cbm/cart
Seat and back	Laminated plywood with laminate or linoleum, composite or oak veneer and fully or partially upholstered
Frame	Tubular steel
Stackable	Floor: 10 pcs. Trolley 12 pcs.

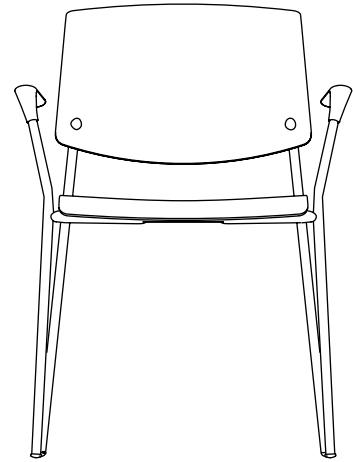

PAUSE WITH ARMREST

Item No.	Product	Without upholstery	A	B	C	1	2
MO 8662	Seat and back in plywood with laminate or linoleum	480					
MO 8662	Seat and back in plywood with oak veneer	510					
MO 8662	Seat and back in black composite	445					
MO 8662	Seat and back in beige or brown-grey composite	515					
MO 8662	Back in laminate/linoleum/composite and seat upholstered		555	585	630	655	725
MO 8662	Seat and back fully upholstered		595	670	760	820	915

OPTIONS - ADDITIONAL PRICE

Item No.	Product	Price
	Seat and back in black-stained oak	80
	Black screws in the back when the frame is black	25

ACCESSORIES

Item No.	Product	Price
MO 1210	Linking device, fixed to Pause armchair - bright chrome	70
MO 1202	Linking device, detachable, for Pause armchair - bright chrome	70
MO 1186	Trolley, painted black	1.350
MO 1501	Writing tablet, removable, white compact laminate with black core. Tubular steel in bright chrome	275
MO 1600	4 pcs loose hard glides, black, for soft floors	20
MO 1601	4 pcs. loose, less hard plastic glides, dark grey (for hard floors)	20
MO 1602	4 pcs. felt glides	20
MO 1834-1	1 set composite seat and back, black + screws	195
MO 1834-2	1 set composite seat and back, beige/brown-grey + screws	260

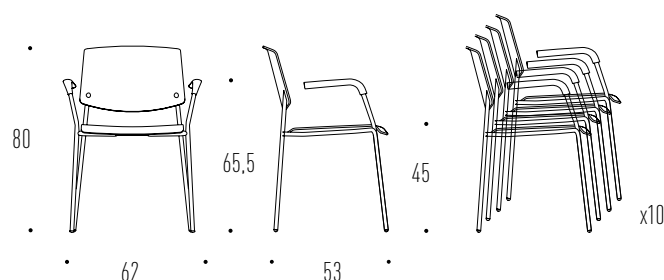

PAUSE WITH ARMREST POINTING FORWARDS

DESIGN: (2005) BUSK + HERTZOG

SPECIFICATIONS & MEASUREMENTS

Description	Simple and light chair with armrests pointing forward, which can be used for hanging up the chairs.
Measurement	W60 x D53 x H80 x SH45 cm
Weight	Gross/Net: 8,8/7,7 kg/pc. 4 pcs/cart. 0,49 cbm/cart
Seat and back	Laminated plywood with laminate or linoleum, composite or oak veneer and fully or partially upholstered
Frame	Tubular steel

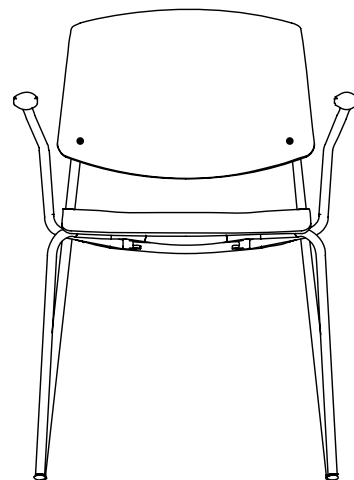

PAUSE WITH ARMREST POINTING FORWARDS

Item No.	Product	Without upholstery	A	B	C	1	2
MO 8653	Seat and back in plywood with laminate or linoleum	480					
MO 8653	Seat and back in plywood with oak veneer	510					
MO 8653	Seat and back in black composite	445					
MO 8653	Seat and back in beige or brown-grey composite	515					
MO 8653	Back in laminate/linoleum/composite and seat upholstered		555	585	630	655	725
MO 8653	Seat and back fully upholstered		595	670	760	820	915

OPTIONS - ADDITIONAL PRICE

Item No.	Product	Price
	Seat and back in black-stained oak	80
	Black screws in the back when the frame is black	25

ACCESSORIES

Item No.	Product	Price
MO 1600	4 pcs loose hard glides, black, for soft floors	20
MO 1601	4 pcs. loose, less hard plastic glides, dark grey (for hard floors)	20
MO 1602	4 pcs. felt glides	20
MO 1834-1	1 set composite seat and back, black + screws	195
MO 1834-2	1 set composite seat and back, beige/brown-grey + screws	260

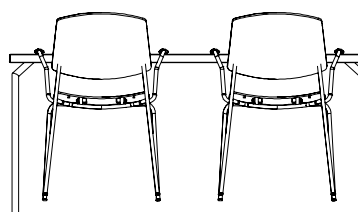
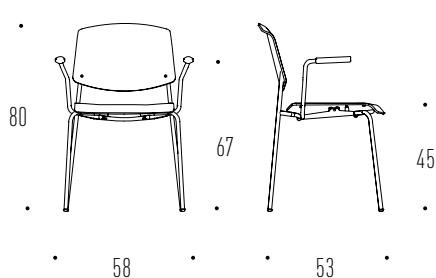

PAUSE RUNNER

DESIGN: (2016) BUSK + HERTZOG

SPECIFICATIONS & MEASUREMENTS

Description	Pause Runner is particularly suitable for row settings, stacking and storage on a trolley.
Measurement	W52 x D54 x H81 x SH45 cm
Weight	Gross/Net: 6,5/6 kg/pc. 4 pcs/cart. 0,395 cbm/cart
Seat and back	Laminated plywood with laminate or linoleum or oak veneer and fully or partially upholstered
Frame	Tubular steel
Stackable	Without upholstery: Floor: 20 pcs. Trolley: 40 pcs. With upholstery: Floor: 10-12 pcs. Trolley: 20 pcs.

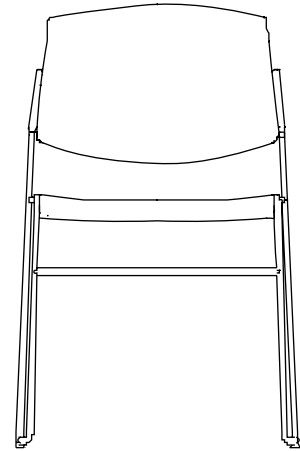

PAUSE RUNNER

Item No.	Product	Without upholstery	A	B	C	1	2
MO 8640	Seat and back in plywood with laminate or linoleum	400					
MO 8640	Seat and back in plywood with oak veneer	485					
MO 8640	Back in laminate/linoleum/composite and seat upholstered		460	500	540	565	605
MO 8640	Seat and back fully upholstered		480	550	640	700	790

OPTIONS - ADDITIONAL PRICE

Item No.	Product	Price
	Seat and back in black-stained oak	80
	Built-in linking device (Minimum purchase 100 pcs.)	60

ACCESSORIES

Item No.	Product	Price
MO 1606	4 pcs loose, plastic glides, transparent	15
MO 1607	4 pcs loose, felt glides, transparent	35
MO 1503	Writing tablet, detachable - white laminate	275
MO 1156	Trolley, painted black, for up to 40 chairs	1.170

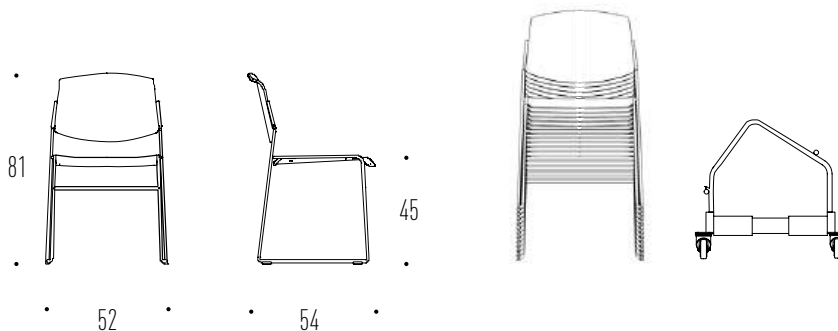

PAUSE BAR STOOL

DESIGN: (2006) BUSK + HERTZOG

SPECIFICATIONS & MEASUREMENTS

Description	Light bar chair with curved seat that makes it possible to sit up from all sides. Available in two heights, Bar and Counter height.
Measurement	MO 8664: W41 x D35 x H81 x SH81 cm MO 8663: W41 x D35 x H65 x SH65 cm
Weight	Gross/Net: 5,9/4,5 kg/pc. 2 pcs/cart. 0,339 kbm/kart
Seat	Laminated plywood with laminate/linoleum, oak veneer or upholstery
Frame	Tubular steel

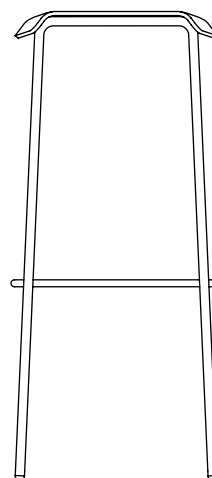

PAUSE BAR STOOL

Item No.	Product	Without upholstery	A	B	C	1	2
MO 8664, MO 8663	Seat in oak with laminate/linoleum	415					
MO 8664, MO 8663	Seat in oak	435					
MO 8664, MO 8663	Seat upholstery		460	530	580	610	660

OPTIONS - ADDITIONAL PRICE

Item No.	Product	Price
	Seat in black-stained oak	80

ACCESSORIES

Item No.	Product	Price
MO 1600	4 pcs. hard plastic glides, black (for soft floors)	20
MO 1601	4 pcs. less hard plastic glides, grey (for soft floors)	20
MO 1602	4 pcs. felt glides	20

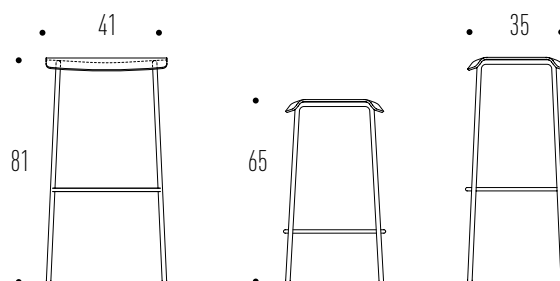

INFERNO

DESIGN: (2005) PELIKAN DESIGN

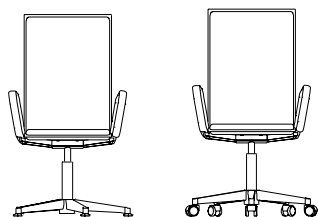

An office and meeting room chair in an elegant design with great lumbar support. The chair is available with characteristic channel stitching further emphasizing the slim and simple lines of the chair.

FRAME COLOURS



Polished
aluminium



Aluminium in
matt, black
grained lacquer

RECOMMENDED FABRIC, LEATHER & ARTIFICIAL LEATHER

GROUP A	GROUP B	GROUP C	LEATHER 1	LEATHER 2
Mainline Plus	Remix 3, Fame, Synergy	Hallingdal 65	Sydney, Hero, Zea	Savanne, Vacona, Fauna

See the overview of fabric, leather and artificial leather on page 86

INFERNO

DESIGN: (2005) PELIKAN DESIGN

SPECIFICATIONS & MEASUREMENTS

Description	Extremely comfortable office chair for the long days at the desk and the meeting table.
Measurement	W64 x D64 x H106-121 x SH44-58 cm
Weight	Gross/Net: 16,9/14,9 kg/pc. 1pcs/cart. 0,440 cbm/cart
Seat and back	Fully upholstered
Frame	Aluminium
MO 5426	Glides, height adj. and tilting mech
MO 5406	Castors, height adj. and tilt. mech



INFERNO

Item No.	Product	A	B	C	1	2
MO 5426, MO 5406	Fully upholstered	2.110	2.200	2.325	2.405	3.160

OPTIONS - ADDITIONAL PRICE

Item No.	Product	Price
	Base and armrest in black, grained lacquer	80
	Channel stitchings	205

ACCESSORIES

Item No.	Product	Price
MO 1608	1 set (5 pcs..) plastic glides, hard (for soft floors)	115
MO 1609	1 set (5 pcs..) plastic glides with felt (hard floors)	115
MO 1611	1 set (5 pcs..) Soft castors (for hard floors)	115
MO 1622	1 set (5 pcs..) Hard castors (for soft floors)	115

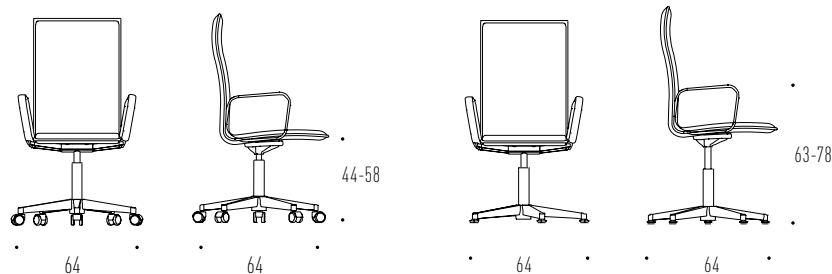

SESSION SERIES

DESIGN: (2003) BUSK + HERTZOG

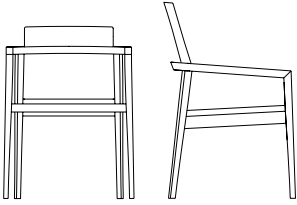

Japanese and Scandinavian aesthetics meet classic shaker traditions in the stackable armchairs in the Session Series. A simple design with a strong sense of form, meeting all demands with regards to comfort, strength and applicability.

WOOD & TREATMENTS

See product details on the individual product pages



Oak, transparent lacquer Oak, natural oil Oak, white-oil Oak, soap treatment Oak, black-stained

RECOMMENDED FABRIC, LEATHER & ARTIFICIAL LEATHER

GROUP A	GROUP B	GROUP C	LEATHER 1	LEATHER 2
Cura, Main Line Plus	Frame, Remix 3, Illusion, Haku	Hallingdal 65	Hero, Zea	Savanne, Fauna, Triumph Crib (Triumph Crib suitable for use within the Care sector)

See the overview of fabric, leather and artificial leather on page 86

SESSION

DESIGN: (2003) BUSK + HERTZOG

SPECIFICATIONS & MEASUREMENTS

Description	Japanese and Scandinavian aesthetics meet shaker traditions in this stackable armchair.
Measurement	W58 x D52 x H77 x SH45 cm
Weight	Gross/Net: 7/6 kg/pc. 6 pcs/cart. 0,550 cbm/cart
Seat and back	Fully upholstered back and seat. Seat cushion is detachable and can be revolved 180°
Frame	Solid oak
Stackable	Floor: 10 pcs. Trolley: 10 pcs.



SESSION

Item No.	Product	A	B	C	1	2
MO 9401	Seat and back upholstered	805	860	930	975	1.040

OPTIONS - ADDITIONAL PRICE

Item No.	Product	Price
	Frame in black-stained oak	80
MO 1826	Removable seat cover and urinary cover over foam	95

ACCESSORIES

Item No.	Product	Price
MO 1203	Linking device, removable, in stainless steel	65
MO 1637	2 built-in castors in front legs	185
MO 1694	Floor mounting brackets	50
MO 1194	Trolley for 10 chairs	1.060
MO 1616	4 pcs. plastic glides, white	20
MO 1617	4 pcs. felt glides, white	20

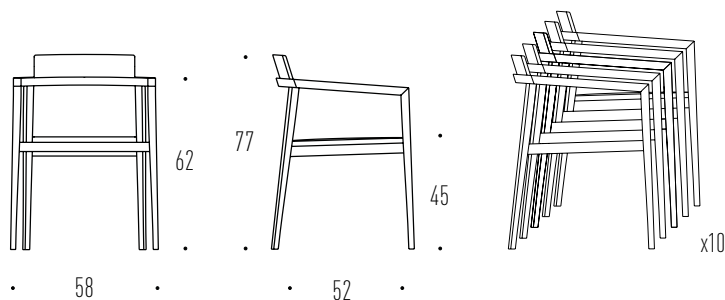

SESSION RELAX

DESIGN: (2003) BUSK + HERTZOG

SPECIFICATIONS & MEASUREMENTS

Description	Minimalistic design with great seating comfort, which makes it suitable as a conference/resting chair.
Measurement	W63 x D60 x H92 x SH45 cm
Weight	Gross/Net: 11.6/10 kg/pc. 3 pcs/cart. 0.550 cbm/cart
Back height	44 cm
Seat and back	Fully upholstered, removable back and seat cushion. Seat cushion is detachable and can be revolved 180°
Frame	Solid oak
Stackable	Floor: 6 pcs. Trolley: 6 pcs.

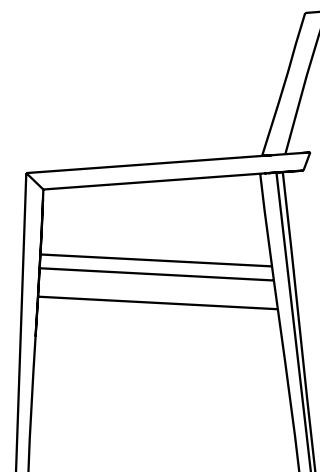

SESSION RELAX

Item No.	Product	A	B	C	1	2
MO 9406	Seat and back upholstered	960	1.085	1.235	1.330	1.485

OPTIONS - ADDITIONAL PRICE

Item No.	Product	Price
	Frame in black-stained oak	80
MO 1827	Removable seat cover and urinary cover over foam	95

ACCESSORIES

Item No.	Product	Price
MO 1203	Linking device, removable, in stainless steel	65
MO 1637	2 built-in castors in front legs	185
MO 1694	Floor mounting brackets	50
MO 1194	Trolley for 6 chairs	1.060
MO 1616	4 pcs. plastic glides, white	20
MO 1617	4 pcs. felt glides, white	20

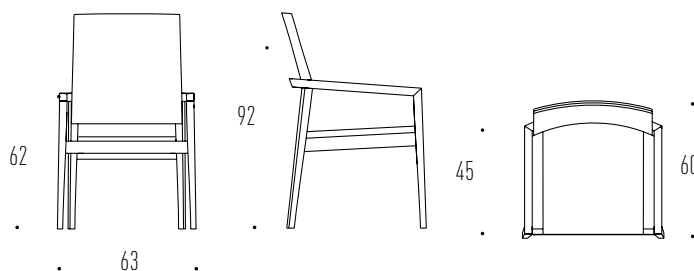

45-SERIES

DESIGN: (1971) RUD THYGESEN & JOHNNY SØRENSEN

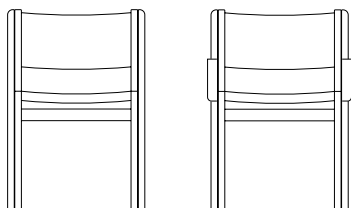

The 45-series chairs are simple and strong wooden chairs with or without armrests, all extremely suitable for spaces where there are extraordinary high demands with regards to strength, durability, stability, comfort as well as functionality, both in use and during cleaning. The series also consists of a large number of accessories, such as, removable seat, slide castors, linking devices, and transport cart etc.

WOOD & TREATMENTS



Laminated beech
with oak veneer with
transparent lacquer

RECOMMENDED FABRIC, LEATHER & ARTIFICIAL LEATHER

GROUP A	GROUP B	GROUP C	LEATHER 1	LEATHER 2
Cura, Main Line Plus	Fame, Remix 3, Illusion, Haku	Hallingdal	Sydney, Hero, Zea	Savanne, Fauna, Triumph Crib (Triumph Crib suitable for use within the Care sector)

See the overview of fabric, leather and artificial leather on page 86

45-SERIES

DESIGN: (1971) RUD THYGESEN & JOHNNY SØRENSEN

SPECIFICATIONS & MEASUREMENTS

Description	Suitable for places where high demands are placed on strength, durability, and stability.
Measurement	W54 x D56 x H78 x SH45 cm
Weight	Gross/Net: 8/6,9 kg/pc. 6 pcs/cart. 0,475 cbm/cart
Seat and back	Upholstered
Frame	Laminated beech with top veneer in oak
Stackable	Floor: 8 pcs. Trolley: 25 pcs. 25 pcs. MO4554 stacked on trolley: H230 cm

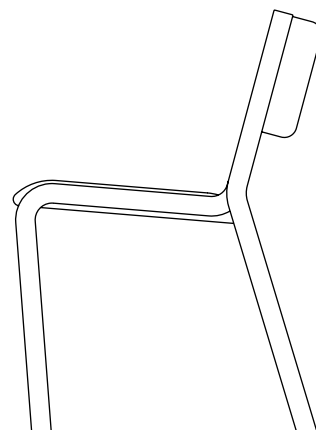

45-SERIES

Item No.	Product	A	B	C	1	2
MO 4554	Seat and back upholstered	565	630	705	755	835

OPTIONS - ADDITIONAL PRICE

Item No.	Product	Price
MO 1829	Removable seat cover and urinary cover over foam	95
MO 1830	Removable seat cover and linen over seat foam	95
MO 1821	Additional, removable seat cover	150

INFO: MO 1821 is for chairs, delivered originally with removable seat cover - additional seat cover.

ACCESSORIES

Item No.	Product	Price
MO 1303	Double hang-up bracket	190
MO 1302	Single hang-up bracket	125
MO 1216	Fixed linking device, steel	65
MO 1245	Removable linking device, black plastic	30
MO 1166	Trolley, painted black. For 20 chairs (H196 cm) - for 25 chairs (H230 cm)	1.170
MO 1610	Slide castors for front legs, 1 set	210
MO 1643	2 built-in castors in front legs	135
MO 1626	4 pcs. plastic glides, white	20
MO 1625	4 pcs. felt glides, white	20

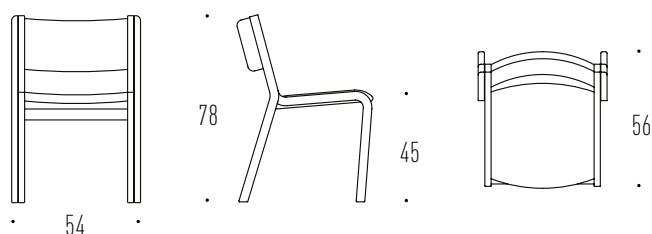

45-SERIES WITH ARMREST

DESIGN: (1971) RUD THYGESEN & JOHNNY SØRENSEN

SPECIFICATIONS & MEASUREMENTS

Description	Suitable for places where high demands are placed on strength, durability, and stability.
Measurement	W61 x D56 x H78 x SH45 cm
Weight	Gross/Net: 8,5/7,3 kg/pc. 6 pcs/cart. 0,54 cbm/cart
Seat and back	Upholstered
Frame and armrest	Laminated beech with top veneer in oak venner
Stackable	Floor: 8 pcs. Trolley: 8 pcs.

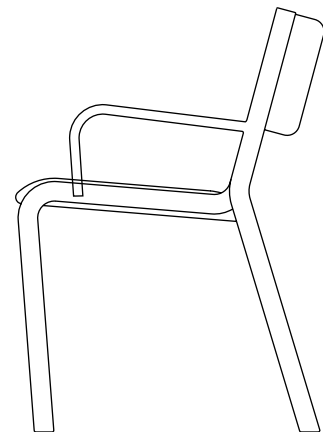

45-SERIES WITH ARMREST

Item No.	Product	A	B	C	1	2
MO 4564	Chair in laminated wood with oak veneer	710	775	850	900	980

OPTIONS - ADDITIONAL PRICE

Item No.	Product	Price
MO 1829	Removable seat cover and urinary cover over foam	95
MO 1830	Removable seat cover and linen over seat foam	95
MO 1821	Additional, removable seat cover	150

INFO: MO 1821 is for chairs, delivered originally with removable seat cover - additional seat cover.

ACCESSORIES

Item No.	Product	Price
MO 1504	Detachable writing tablet	300
MO 1166	Trolley, painted black. For 20 chairs (H196 cm)	1.170
MO 1610	Slide castors for front legs, 1 set	210
MO 1643	2 built-in castors in front legs	135
MO 1626	4 pcs. plastic glides, white	20
MO 1625	4 pcs. felt glides, white	20

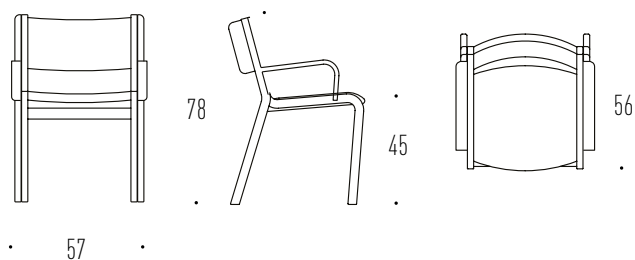

TONICA WOOD

DESIGN: (2013) NIELS GAMMELGAARD

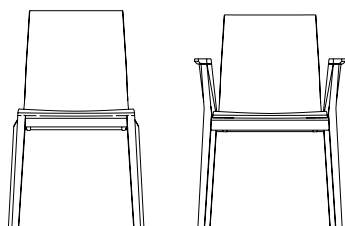

A modern idea of a simple wooden chair with a strong sense of form. Tonica Wood has a good lumbar support and flexibility in the back, ensuring a very high seating comfort. The chair is available in all wood and fully or partially upholstered, with or without armrests, and can be stacked.

WOOD & TREATMENTS



Oak,
transparent
lacquer



Oak, black-stained

RECOMMENDED FABRIC, LEATHER & ARTIFICIAL LEATHER

GROUP A	GROUP B	GROUP C	LEATHER 1	LEATHER 2
Cura, Main Line Plus	Fame, Remix 3, Illusion, Haku	Hallingdal 65	Hero, Sydney, Zea	Savanne, Vacona, Fauna

See the overview of fabric, leather and artificial leather on page 86

TONICA WOOD

DESIGN: (2013) NIELS GAMMELGAARD

SPECIFICATIONS & MEASUREMENTS

Description	Strong wooden chair with great lumbar support and flexibility in the back.
Measurement	W52 x D55 x H80 x SH45 cm
Weight	Gross/Net: 6,5/6 kg/pc. 3 pcs/cart. 0,41 cbm/cart
Seat and back	Laminated plywood with veneer in oak
Frame	Solid oak
Stackable	Without upholstery: Floor: 9 pcs. Trolley 9 pcs. With upholstery: Floor: 6 pcs. Trolley 6 pcs.

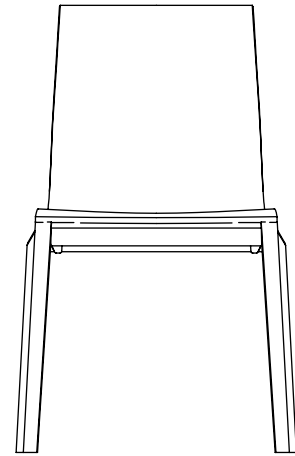

TONICA WOOD

Item No.	Product	Without upholstery	A	B	C	1	2
MO 5330	Chair in oak	545					
MO 5330	Fully upholstered		670	825	1.020	1.140	1.335
MO 5330	Front side upholstered		715	875	1.080	1.205	1.410

OPTIONS - ADDITIONAL PRICE

Item No.	Product	Price
	Frame and shell in black-stained oak	80

ACCESSORIES

Item No.	Product	Price
MO 1204	Linking device, detachable (incl. of brackets on each chair)	80
MO 1211	Linking device/hymn book holder	105
MO 1616	4 pcs plastic glides, white	20
MO 1617	4 pcs felt glides, white	20
MO 1637	2 built-in castors in front legs	185
MO 1194	Trolley for 6-9 chairs	1.060

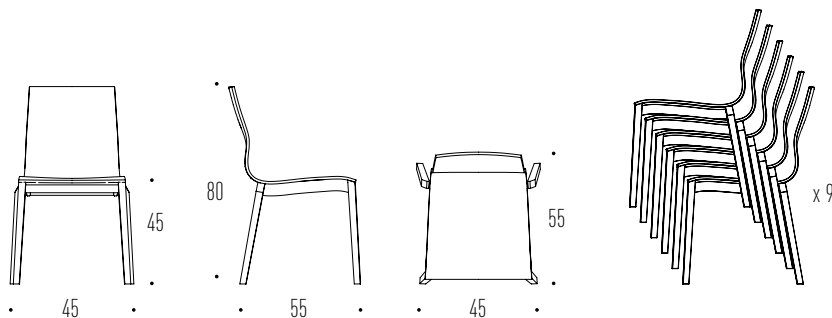

TONICA WOOD WITH ARMREST

DESIGN: (2013) NIELS GAMMELGAARD

SPECIFICATIONS & MEASUREMENTS

Description	Strong wooden chair with armrest and great lumbar support and flexibility in the back.
Measurement	B59 x D55 x H80 x SH45 cm
Weight	Gross/Net: 8/7,5 kg/pc. 3 pcs/cart. 0,41 cbm/cart
Seat and back	Laminated plywood with veneer in oak
Frame and armrest	Solid oak
Stackable	Without upholstery: Floor: 9 pcs. Trolley 9 pcs. With upholstery: Floor: 6 pcs. Trolley 6 pcs.

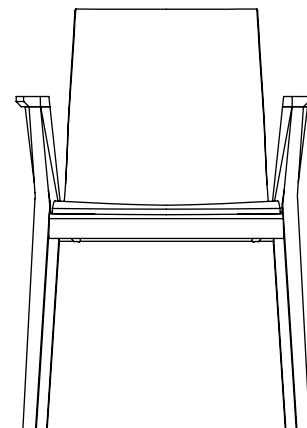

TONICA WOOD WITH ARMREST

Item No.	Product	Without upholstery	A	B	C	1	2
MO 5331	Chair in oak	650					
MO 5331	Fully upholstered		780	935	1.125	1.250	1.445
MO 5331	Front side upholstered		825	990	1.190	1.320	1.520

OPTIONS - ADDITIONAL PRICE

Item No.	Product	Price
	Frame and shell in black-stained oak	80

ACCESSORIES

Item No.	Product	Price
MO 1205	Linking device, detachable (incl. of brackets on each chair)	80
MO 1212	Linking device/hymn book holder	110
MO 1616	4 pcs plastic glides, white	20
MO 1617	4 pcs felt glides, white	20
MO 1637	2 built-in castors in front legs	185
MO 1194	Trolley for 6-9 chairs	1.060

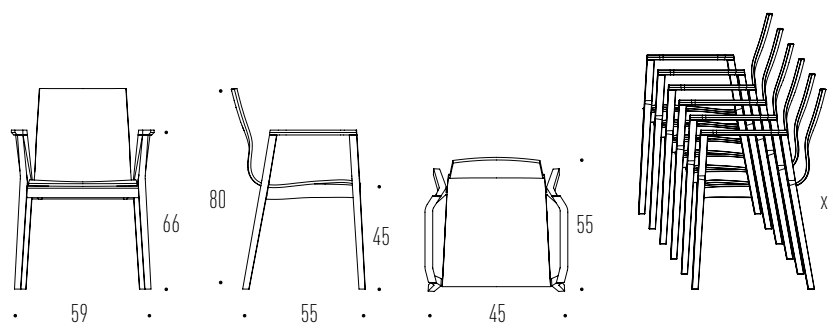

SOLACIA

DESIGN: (2015) LONE STORGAARD

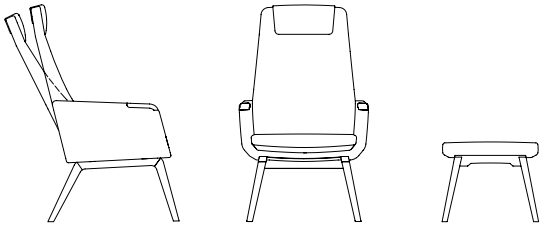

The Solacia resting chair is particularly suitable for the Care sector - created via user-driven innovation in a close cooperation between Gentofte Hospital, users, Magnus Olesen and designer Lone Storgaard. Solacia has a clear and stringent design, is comfortable, has slightly rounded shapes and is adapted to users who will sit in the chairs for longer periods of time to rest.

WOOD & TREATMENTS



Oak, transparent
lacquer

RECOMMENDED FABRIC, LEATHER & ARTIFICIAL LEATHER

GROUP A	GROUP B	GROUP C	LEATHER 1	LEATHER 2
Cura	Fame, Illusion, Haku, Remix 3	Hallingdal 65	Hero, Zea	Triumph Crib (Triumph Crib suitable for use within the Care sector)

See the overview of fabric, leather and artificial leather on page 86

SOLACIA CHAIR & STOOL

DESIGN: (2015) LONE STORGAARD

SPECIFICATIONS & MEASUREMENTS

- Description** An extremely comfortable resting chair with stool, developed especially for the care and health sector.
- Measurement** Chair: W60 x D69 x H113 cm
Stool: W50 x D40,5 x H39/41 cm
- Seat and back** Fully upholstered. The seat cushion of the chair is detachable and is available with removable seat cover and urinary cover
- Frame and armrest Details** Solid oak with transparent lacquer
The chair has a tilting mechanism to regulate the back tilt up to 12° and a detachable neck support. The stool also has a tilting mechanism.



SOLACIA CHAIR

Item No.	Product	A	B	C	1	2
MO 8473	Fully upholstered	3.250	3.785	4.415	4.815	5.460

SOLACIA STOOL

Item No.	Product	A	B	C	1	2
MO 8470	Fully upholstered	795	880	975	1.040	1.140

OPTIONS - ADDITIONAL PRICE

Item No.	Product	Price
	Additional price for neck cushion in leather	150
MO 1831	Urinary cover over seat foam - seat cover detachable for MO 8473 (Solacia Chair)	155

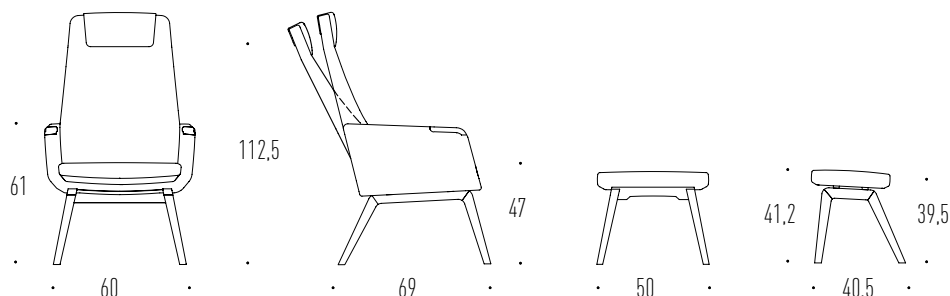

ADDI MEETING

DESIGN: (2013) FRIIS & MOLTKE DESIGN

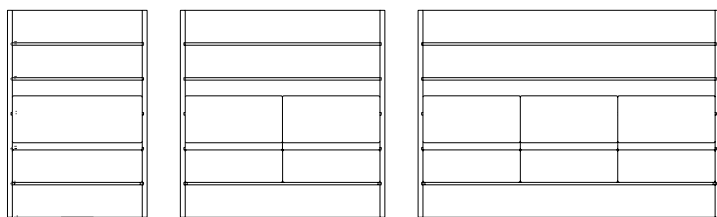

The purpose of Addi Meeting is as a flexible furniture element, ideal where people meet in various connections. Furniture element with high screening walls on the sides and the back, offering a more private *room in the room*. Addi Meeting is available as 1-, 2- and 3-seater modules. Seat and back cushions are detachable and thus easy to exchange and combinations of colours within each element become possible.

WOOD & TREATMENTS



Oak, transparent
lacquer

BASE COLOURS



Black painted

RECOMMENDED FABRIC, LEATHER & ARTIFICIAL LEATHER

GROUP A	GROUP B	GROUP C	LEATHER 1	LEATHER 2
Cura	Fame, Remix 3, Illusion	Hallingdal 65	Hero, Zea	Savanne, Fauna

See the overview of fabric, leather and artificial leather on page 86

ADDI MEETING

DESIGN: (2013) FRIIS & MOLTKE

SPECIFICATIONS & MEASUREMENTS

- Description** A flexible furniture element with high screening walls on the sides and back, offering a more private lounge area - especially suitable for open office environments
- Measurement** 3 size variants (1,2,3 seaters)
- Seat and back** Fully upholstered seat and back, both are detachable with side wall and back wall
- Frame** Painted black



ADDI MEETING 1-SEATER

Item No.	Product	Size	A	B	C	1	2
MO 5354	Upholstered	W86 x D63 x H130 X SH45	3.195	4.055	4.270	5.730	6.770

ADDI MEETING 2-SEATER

Item No.	Product	Size	A	B	C	1	2
MO 5356	Upholstered	W126 x D63 x H130 X SH45	4.710	5.875	6.165	8.135	9.540

ADDI MEETING 3-SEATER

Item No.	Product	Size	A	B	C	1	2
MO 5357	Upholstered	W186 x D63 x H130 X SH45	6.905	8.510	8.905	11.620	13.555

MO 5354

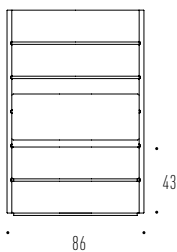

MO 5356

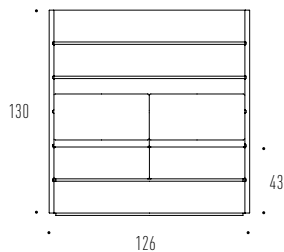

MO 5357

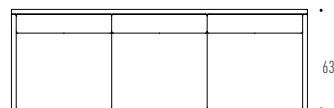
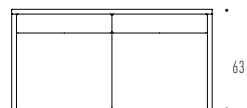
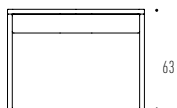
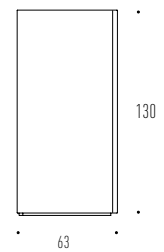
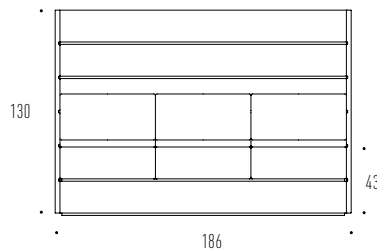

SLENDER

DESIGN: (2017) ANTONIO SCAFFIDI



Slender is a table with a slender expression and a continuously flowing contour along its edges. Legs and table top are arranged to visually unify these elements as one. This also underlines the pragmatic functionality of the design - no space is wasted. All corners are rounded softly. The core of the table top consists of Honeycomb which minimize material consumption and, at the same time, makes it strong and light-weight.

WOOD & TREATMENTS

See product details on the individual product pages



Oak, transparent lacquer
Oak, natural oil
Oak, white-oil
Oak, soap treatment
Oak, black-stained

LINOLEUM



Pebble 4175 NCS 3502-Y
Ash 4132 NCS 5502-G
Black 4023 NCS 9000-N

LAMINATE



Grey U1115 W Duropol NCS S4502-G
White F7949 Soft white Formica RAL 9016
Graphite F7837 Graphite Formica RAL8019
Wood pattern oak F 5374 Elegant oak Formica

CERTIFICATIONS



EU Ecolabel: DK/049/016

EU Ecolabel certification on specific products:

All Slender Dining Table variants in veneer

SLENDER

DESIGN: (2017) ANTONIO SCAFFIDI

SPECIFICATIONS & MEASUREMENTS

Description	A slim table with a continuously flowing contour along its edges, where legs and table top are combined.
Table height	74 cm
Table top	Light weight table top with rounded, beveled edges in solid oak
Surface	Oak veneer or linoleum/laminate (with linoleum, the edge is available in transparent lacquer or soap treatment)
Table legs	Solid oak



SLENDER

Item No.	Size	Price
MO 7100-1	80 x 80 cm	1.415
MO 7100-2	80 x 120 cm	1.605
MO 7100-12	80 x 140 cm	1.700
MO 7100-3	80 x 160 cm	1.795
MO 7100-4	80 x 180 cm	1.890
MO 7100-5	80 x 200 cm	1.985
MO 7100-14	80 x 220 cm	2.080
MO 7100-6	90 x 90 cm	1.515
MO 7100-7	90 x 120 cm	1.670
MO 7100-13	90 x 140 cm	1.775
MO 7100-8	90 x 160 cm	1.880
MO 7100-9	90 x 180 cm	1.980
MO 7100-10	90 x 200 cm	2.085
MO 7100-15	90 x 220 cm	2.190
MO 7100-11	100 x 200 cm	2.285

OPTIONS - ADDITIONAL PRICE

Item No.	Product	Price
	Black-stained legs + edging for tables with linoleum/laminate	315
	Black-stained table top, legs, edgings for tables in veneer	315
	Hidden castors in two of the legs - price per castor	40

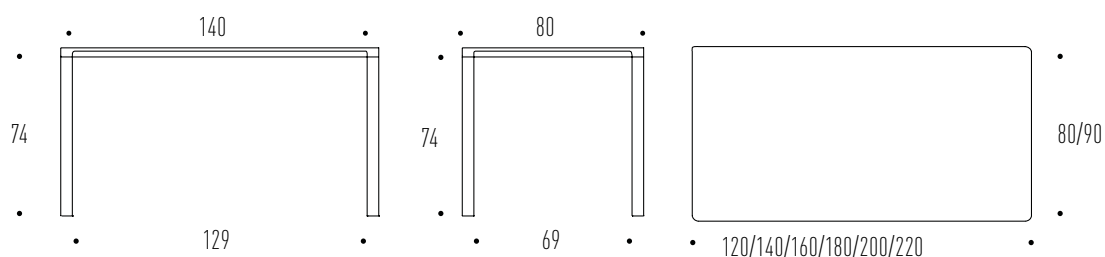

SLENDER COFFEE TABLE

DESIGN: (2017) ANTONIO SCAFFIDI

SPECIFICATIONS & MEASUREMENTS

Description A series of nesting tables with a slim look and a continuous contour along the edges where its legs and table top are combined.

Table height 45 or 50 cm

Table top Solid oak with rounded edges and corners

Table legs Solid oak



SLENDER COFFEE TABLE

Item No.	Size	Price
MO 7110-2	40 x 32 cm	490
MO 7110-3	48 x 48 cm	690
MO 7110-1	80 x 80 cm	855
MO 7110-4	75 x 32 cm	690
MO 7110-5	120 x 40 cm	855

OPTIONS - ADDITIONAL PRICE

Product	Price
Table top and frame in black-stained oak	150

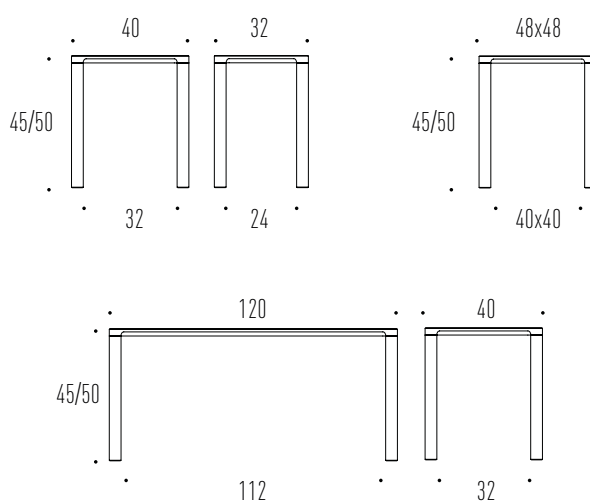

MIX TABLE SERIES

DESIGN: (1997) RUD THYGESEN & JOHNNY SØRENSEN

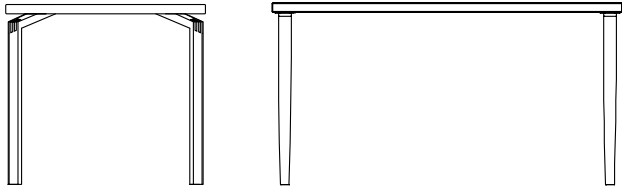

A simple modular table solution without rails – with many options. Thanks to the 'Honeycomb' table top, the table is light but at the same time robust and long-lasting. The tables can stand alone or be linked together by linking devices and additional leaves for individual arrangements. The Mix tables is available in classic finger joint wooden legs and standard conical wooden legs and folding leg.

WOOD & TREATMENTS

See product details on the individual product pages

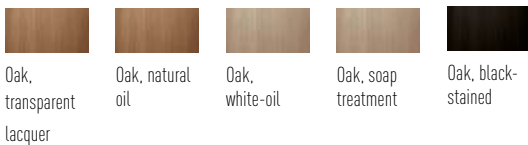

LINOLEUM

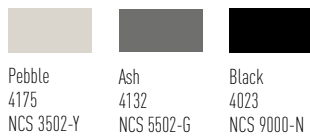

LAMINATE

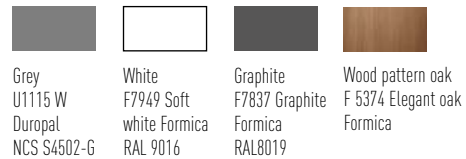

TABLE LEGS



SOLID, FINGER JOINT WOODEN LEGS

MO 7003

STANDARD CONICAL WOODEN LEGS

MO 7020 - STRAIGHT
MO 7021 - SLANTED

CONICAL WOODEN LEGS WITH FOLDING FUNCTION

MO 7007 - STRAIGHT
MO 7009 - SLANTED

FOLDING FUNCTION

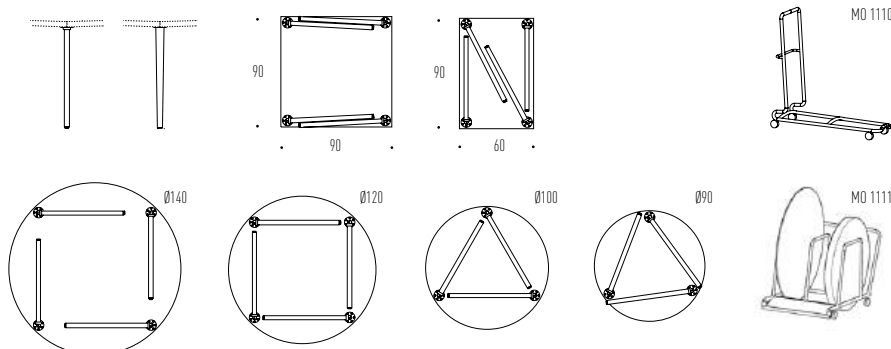

MIX TABLE SERIES

DESIGN: (1997) RUD THYGESEN & JOHNNY SØRENSEN

DIMENSIONS

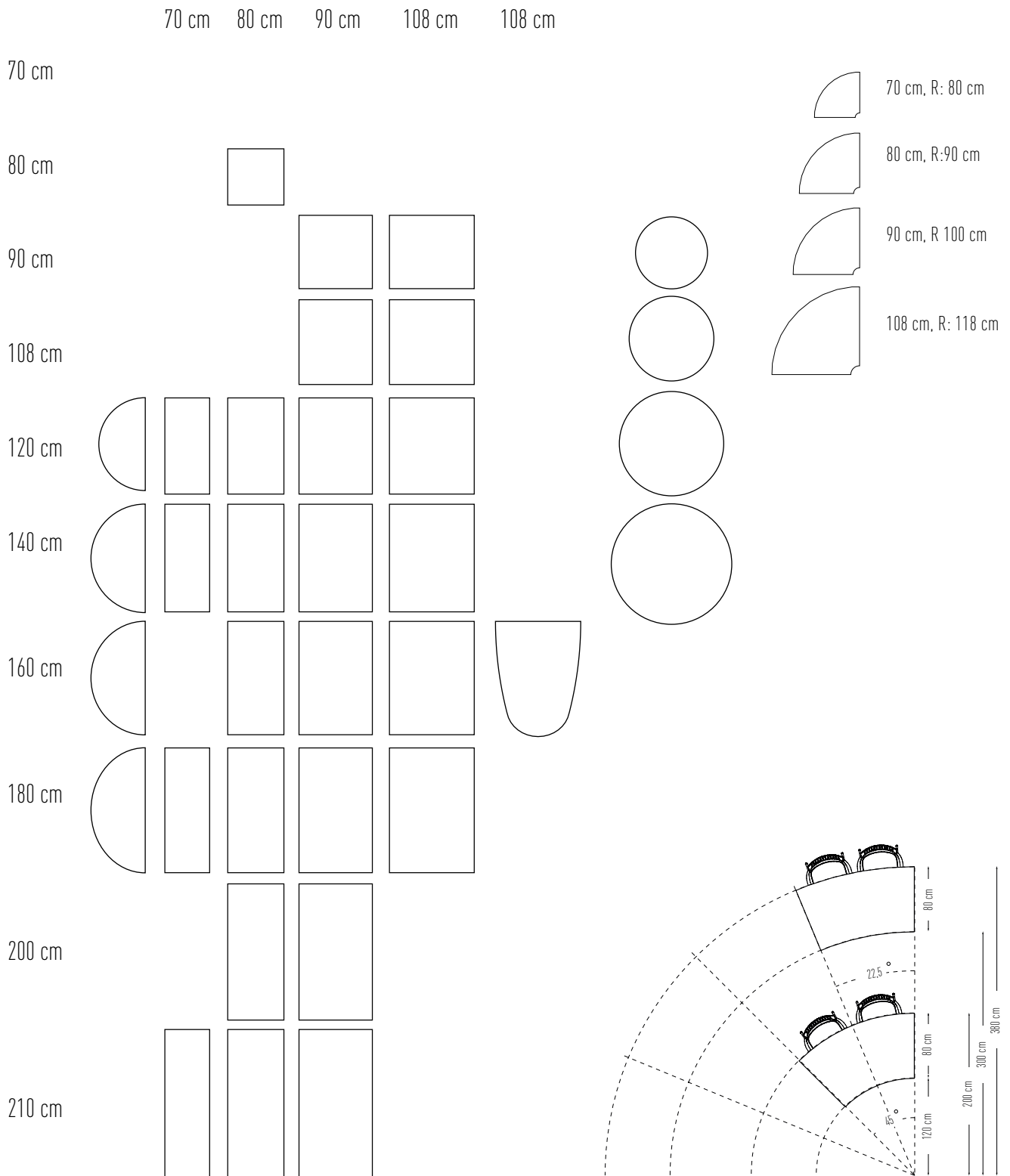

MIX WITH SOLID, FINGER JOINT WOODEN LEGS

DESIGN: (1997) RUD THYGESEN & JOHNNY SØRENSEN

SPECIFICATIONS & MEASUREMENTS

Description	Rectangular/square tables with solid, finger joint wooden legs.
Table height	50 or 74 cm
Table top thickness	37 mm
Table top	A core of honeycomb. Before the surface is glued on, 2x4 mm MDF is glued on the top and bottom side with surface in linoleum/laminate or oak veneer with edges in oak
Table legs	Solid oak
Extension leaf	With bushes for linking device or tenons



MIX WITH SOLID, FINGER JOINT WOODEN LEGS - RECTANGULAR/SQUARE

Item No.	Size	Table MO 7003	Extension leaf MO 7001
MO 7003-1	120 x 70 cm	1.405	625
MO 7003-2	140 x 70 cm	1.485	705
MO 7003-4	180 x 70 cm	1.640	860
MO 7003-6	80 x 80 cm	1.290	510
MO 7003-8	120 x 80 cm	1.465	685
MO 7003-9	140 x 80 cm	1.550	770
MO 7003-10	160 x 80 cm	1.640	860
MO 7003-11	180 x 80 cm	1.725	945
MO 7003-12	200 x 80 cm	1.810	1.030
MO 7003-65	210 x 80 cm	1.895	1.115
MO 7003-13	90 x 90 cm	1.380	600
MO 7003-14	108 x 90 cm	1.465	685
MO 7003-15	120 x 90 cm	1.525	745
MO 7003-16	140 x 90 cm	1.615	835
MO 7003-17	160 x 90 cm	1.715	935
MO 7003-18	180 x 90 cm	1.805	1.025
MO 7003-19	200 x 90 cm	1.900	1.120

See more sizes on the next page

MIX WITH SOLID, FINGER JOINT WOODEN LEGS

DESIGN: (1997) RUD THYGESEN & JOHNNY SØRENSEN

SPECIFICATIONS & MEASUREMENTS

Description	Rectangular/square tables with solid, finger joint wooden legs.
Table height	50 or 74 cm
Table top thickness	37 mm
Table top	A core of honeycomb. Before the surface is glued on, 2x4 mm MDF is glued on the top and bottom side with surface in linoleum/laminate or oak veneer with edges in oak
Table legs	Solid oak
Extension leaf	With bushes for linking device or tenons



MIX WITH SOLID, FINGER JOINT WOODEN LEGS - RECTANGULAR/SQUARE

Item No.	Size	Table MO 7003	Extension leaf MO 7001
MO 7003-20	108 x 108 cm	1.565	785
MO 7003-21	120 x 108 cm	1.630	850
MO 7003-22	140 x 108 cm	1.735	955
MO 7003-23	160 x 108 cm	1.845	1.065
MO 7003-24	180 x 108 cm	1.955	1.175

OPTIONS - ADDITIONAL PRICE

Item No.	Product	Price
	Black-stained legs and edging for tables with linoleum/laminate	315
	Black-stained oak	315
	Hidden castors - not swiveling, price per castor	40

ACCESSORIES

Item No.	Product	Price
MO 1403	Solid finger joint wooden leg for table height 74 cm or 50 cm - per leg	235
MO 1625	4 pcs. felt glides	20
MO 1628	4 pcs. plastic glides	20
MO 2998	Linking device	25
MO 1631	Castor, 75 mm, with brake, per castor	80
MO 1630	Castor, 75 mm, without brake, per castor	70
MO 1702	Wooden wire management cap in oak, beech - aluminium ring, Ø 7 cm, mounted	145

MIX WITH SOLID, FINGER JOINT WOODEN LEGS

DESIGN: (1997) RUD THYGESEN & JOHNNY SØRENSEN

SPECIFICATIONS & MEASUREMENTS

Description	Circular/semi-circular and oval tables with solid, finger joint wooden legs.
Table height	50 or 74 cm
Table top thickness	37 mm
Table top	A core of honeycomb. Before the surface is glued on, 2x4 mm MDF is glued on the top and bottom side with surface in linoleum/laminate or oak veneer with edges in oak
Table legs	Solid oak
Extension leaf	With bushes for linking device or tenons



MIX WITH SOLID, FINGER JOINT WOODEN LEGS - CIRCULAR/SEMI-CIRCULAR

Item No.	MO 7003-50	MO 7003-51	MO 7003-25	MO 7003-26	MO 7003-27	MO 7003-28	MO 7003-38
Size	22,5° 148 X 80 cm	45° 153 X 80 cm	1/2 Ø120	1/2 Ø140	1/2 Ø160	1/2 Ø180	Semi oval 160 x 108 cm
Table 7003	1.790	1.810	1.445	1.595	1.765	1.950	2.040
Extension Leaf 7001	1.010	1.030	665	815	985	1.170	1.260

Item No.	MO 7003-30	MO 7003-31	MO 7003-70	MO 7003-71	MO 7003-62	MO 7003-63	MO 7003-64
Size	Ø 90 cm	Ø 108 cm	Ø 120 cm	Ø 140 cm*)	1/4 Ø 180 80 x 80 cm	1/4 Ø 200 90 x 90 cm	1/4 Ø 236 108 x 108 cm
Table 7003	1.525	1.735	2.125	2.385	1.425	1.520	1.715
Extension Leaf 7001	745	955	1.345	1.605	645	740	935

*) Ø 140 cm available with linoleum or oak veneer. If laminate is desired - contact the factory for possible laminate colours

OPTIONS - ADDITIONAL PRICE

Item No.	Product	Price
	Black-stained legs and edging for tables with linoleum/laminate	315
	Black-stained oak	315

ACCESSORIES

Item No.	Product	Price
MO 1403	Solid finger joint wooden leg for table height 74 cm or 50 cm - per leg	235
MO 1625	4 pcs. felt glides	20
MO 1628	4 pcs. plastic glides	20
MO 2998	Linking device	25
MO 1631	Castor, 75 mm, with brake, per castor	80
MO 1630	Castor, 75 mm, without brake, per castor	70
MO 1702	Wooden wire management cap in oak, beech - aluminium ring, Ø 7 cm, mounted	145

MIX WITH CONICAL WOODEN LEGS

DESIGN: (1997) RUD THYGESEN & JOHNNY SØRENSEN

SPECIFICATIONS & MEASUREMENTS

Description	Rectangular/square tables with conical wooden legs with/without folding
Table height	50 or 74 cm
Table top thickness	37 mm
Table top	A core of honeycomb. Before the surface is glued on, 2x4 mm MDF is glued on top and bottom side with surface: linoleum/laminate or oak veneer with edges in oak
Table legs	Solid oak, straight (MO 7020) or slanted with a 5 degree slant outwards (MO 7021)
Folding legs	Solid oak, straight (MO 7007) or slanted with a 5 degree slant outwards (MO 7009)
Extension leaf	With bushes for linking device or tenons
Stacking	Trolleys for 10 pcs. rectangular or 7 circular/semi.circular tables



MIX WITH CONICAL WOODEN LEGS - RECTANGULAR/SQUARE

Item No.	Size	Table with standard legs	Table with folding legs	Extension leaf
		MO 7020 (straight)/MO 7021 (slanted)	MO 7007 (straight)/MO 7009 (slanted)	MO 7001
MO 7020/7021/7007/7009/7001-1	120 x 70 cm	1.150	1.560	625
MO 7020/7021/7007/7009/7001-2	140 x 70 cm	1.230	1.640	705
MO 7020/7021/7007/7009/7001-4	180 x 70 cm	1.385	1.795	860
MO 7020/7021/7007/7009/7001-6	80 x 80 cm	1.035	1.445	510
MO 7020/7021/7007/7009/7001-8	120 x 80 cm	1.210	1.620	685
MO 7020/7021/7007/7009/7001-9	140 x 80 cm	1.295	1.705	770
MO 7020/7021/7007/7009/7001-10	160 x 80 cm	1.385	1.795	860
MO 7020/7021/7007/7009/7001-11	180 x 80 cm	1.470	1.880	945
MO 7020/7021/7007/7009/7001-12	200 x 80 cm	1.555	1.965	1.030
MO 7020/7021/7007/7009/7001-65	210 x 80 cm	1.640	2.050	1.115
MO 7020/7021/7007/7009/7001-13	90 x 90 cm	1.125	1.535	600
MO 7020/7021/7007/7009/7001-14	108 x 90 cm	1.210	1.620	685
MO 7020/7021/7007/7009/7001-15	120 x 90 cm	1.270	1.680	745
MO 7020/7021/7007/7009/7001-16	140 x 90 cm	1.360	1.770	835
MO 7020/7021/7007/7009/7001-17	160 x 90 cm	1.460	1.870	935
MO 7020/7021/7007/7009/7001-18	180 x 90 cm	1.550	1.960	1.025
MO 7020/7021/7007/7009/7001-19	200 x 90 cm	1.645	2.055	1.120

See more sizes on the next page

MIX WITH CONICAL WOODEN LEGS

DESIGN: (1997) RUD THYGESEN & JOHNNY SØRENSEN

SPECIFICATIONS & MEASUREMENTS

Description	Rectangular/square tables with conical wooden legs with/without folding
Table height	50 or 74 cm
Table top thickness	37 mm
Table top	A core of honeycomb. Before the surface is glued on, 2x4 mm MDF is glued on top and bottom side with surface: linoleum/laminate or oak veneer with edges in oak
Table legs	Solid oak, straight (MO 7020) or slanted with a 5 degree slant outwards (MO 7021)
Folding legs	Solid oak, straight (MO 7007) or slanted with a 5 degree slant outwards (MO 7009)
Extension leaf	With bushes for linking device or tenons
Stacking	Trolley for 10 pcs. rectangular or square folding tables



MIX WITH CONICAL WOODEN LEGS - RECTANGULAR/SQUARE

Item No.	Size	Table with standard legs	Table with folding legs	Extension leaf
		MO 7020 (straight)/MO 7021 (slanted)	MO 7007 (straight)/MO 7009 (slanted)	MO 7001
MO 7020/7021/7007/7009/7001-20	108 x 108 cm	1.310	1.720	785
MO 7020/7021/7007/7009/7001-21	120 x 108 cm	1.375	1.785	850
MO 7020/7021/7007/7009/7001-22	140 x 108 cm	1.480	1.890	955
MO 7020/7021/7007/7009/7001-23	160 x 108 cm	1.590	2.000	1.065
MO 7020/7021/7007/7009/7001-24	180 x 108 cm	1.700	2.110	1.175

OPTIONS - ADDITIONAL PRICE

Product	Price
Black-stained legs and edging for tables with linoleum/laminate	315
Black-stained oak	315
Hidden castors - not swiveling, price per castor	40

ACCESSORIES

Item No.	Product	Price
MO 1625	4 pcs. felt glides	20
MO 1628	4 pcs. plastic glides	20
MO 2998	Linking device	25
MO 1702	Wooden wire management cap in oak, beech - aluminium ring, Ø 7 cm, mounted	145
MO 1110	Trolley, painted black, for tables with folding legs - for approx. 10 tables. W60 x L150 x H135 cm	2.200







MIX WITH CONICAL WOODEN LEGS







DESIGN: (1997) RUD THYGESEN & JOHNNY SØRENSEN

SPECIFICATIONS & MEASUREMENTS

Description	Circular/semi-circular and oval tables with conical wooden legs with/without folding
Table height	50 or 74 cm
Table top thickness	37 mm
Table top	A core of honeycomb. Before the surface is glued on, 2x4 mm MDF is glued on top and bottom side with surface: linoleum/laminate or oak veneer with edges in oak
Table legs	Solid oak, straight (MO 7020) or slanted with a 5 degree slant outwards (MO 7021)
Foldeben	Solid oak, straight (MO 7007) or slanted with a 5 degree slant outwards (MO 7009)
Extension leaf	With bushes for linking device or tenons
Stacking	Trolley for 7 pcs. circular/semi-circular folding tables

MIX WITH CONICAL WOODEN LEGS - CIRCULAR/SEMI-CIRCULAR

							
Item No.	MO 7020-50	MO 7020-51	MO 7020-25	MO 7020-26	MO 7020-27	MO 7020-28	MO 7020-38
Size	22,5° 148 X 80 cm	45° 153 X 80 cm	1/2 Ø120	1/2 Ø140	1/2 Ø160	1/2 Ø180	Semi oval 160 x 108 cm
Standard leg 7020/7021	1.404	1.424	1.059	1.209	1.379	1.564	1.785
Folding leg 7007/7009	1.711	1.731	1.366	1.516	1.686	1.871	2.195
Extension leaf 7001	1.010	1.030	665	815	985	1.170	1.260

							
Item No.	MO 7020-30	MO 7020-31	MO 7020-70	MO 7020-71	MO 7020-62	MO 7020-63	MO 7020-64
Size	Ø 90 cm	Ø 108 cm	Ø 120 cm	Ø 140 cm*)	1/4 Ø 180 80 x 80 cm	1/4 Ø 200 90 x 90 cm	1/4 Ø 236 108 x 108 cm
Standard leg 7020/7021	1.270	1.480	1.870	2.130	1.170	1.265	1.460
Folding leg 7007/7009	1.680	1.890	2.280	2.540	1.580	1.675	1.870
Extension leaf 7001	745	955	1.345	1.605	645	740	935

*) Ø 140 cm available with linoleum or oak veneer. If laminate is desired - contact the factory for possible laminate colours

OPTIONS - ADDITIONAL PRICE

Item No.	Product	Price
	Black-stained legs and edging for tables with linoleum/laminate	315
	Black-stained oak	315
	Hidden castors - not swiveling, price per castor	40

ACCESSORIES

Item No.	Product	Price
MO 1625	4 pcs. felt glides	20
MO 1628	4 pcs. plastic glides	20
MO 2998	Linking device	25
MO 1702	Wooden wire management cap in oak, beech - aluminium ring, Ø 7 cm, mounted	145
MO 1111	Trolley, painted black, for circular/semi-circular tables. W85 x L134 x H101 cm. Internal width: 77 cm	1.960

BRUNCH TABLE SERIES

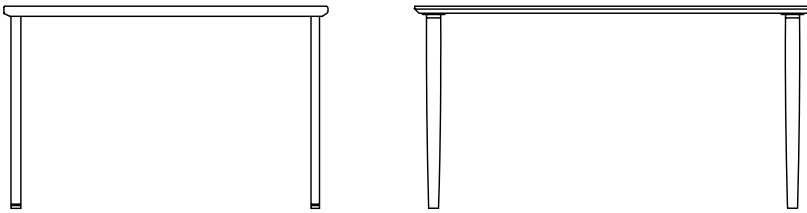

Brunch is a distinctive table with a simple, sleek and clear-cut expression. The 2,2mm slim table top of plywood is robust, and especially with a surface of high-pressure laminate, extremely durable and particularly suitable for canteens, cafés and waiting areas. Brunch is available with steel or wooden legs as a regular standard table, or with foldable legs.

WOOD & TREATMENTS

See product details on the individual product pages

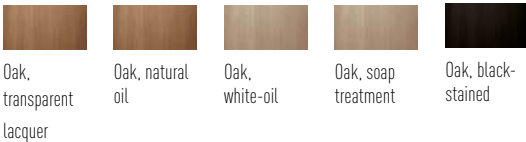

LINOLEUM

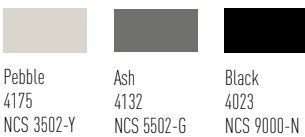

Pebble 4175
NCS 3502-Y

Ash 4132
NCS 5502-G

Black 4023
NCS 9000-N

LAMINATE

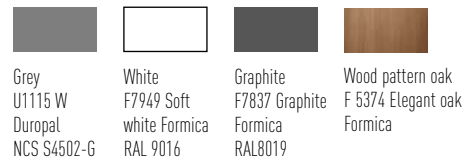

Grey U1115 W
Duropal
NCS S4502-G

White F7949 Soft
white Formica
RAL 9016

Graphite F7837
Graphite Formica
RAL8019

Wood pattern oak F 5374
Elegant oak Formica

STEEL COLOURS



Powder lacquer in black, matt grained lacquer

Bright chrome

TABLE LEGS



STANDARD STEEL LEGS
MO 6671



STANDARD CONICAL WOODEN LEGS
MO 6676



STEEL FOLDING LEGS
MO 6665 - STRAIGHT
MO 6667 - SLANTED

WOODEN FOLDING LEGS
MO 6666 - STRAIGHT
MO 6668 - SLANTED

BRUNCH TABLE SERIES

DIMENSIONER

	70 cm	80 cm	90 cm
80 cm			
90 cm			
120 cm			
140 cm			
180 cm			
200 cm			
210 cm			

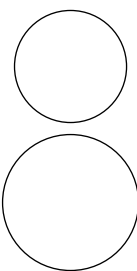

FOLDING FUNCTION

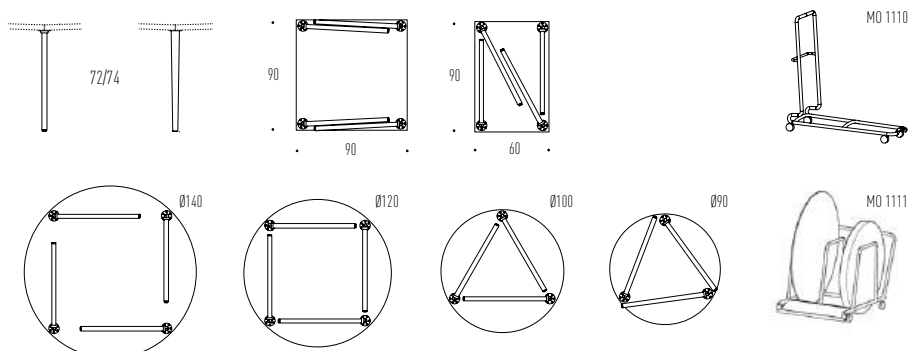

BRUNCH WITH STEEL LEGS

SPECIFICATIONS & MEASUREMENTS

Description	Extremely durable table series with/without folding function.
Table height	74 cm
Table top	25 mm slim table top in plywood with chamfered plywood edge, lacquered or black stained, or straight ABS-edge
Table legs	Steel legs are mounted in a 90 degree angle on table top. Standard with adjustable glide
Folding legs	Straight (MO 6665) or slanted with a 5 degree slant outwards (MO 6667)
Stacking	Trolleys for folding tables - 10 rectangular or 7 circular tables



BRUNCH WITH STEEL LEGS

Item No.	Size	Table with steel legs	Table with steel folding legs
		MO 6671	MO 6665 (straight)/MO 6667 (slanted)
MO 6671/6665/6667-0	70 x 120 cm	780	1.200
MO 6671/6665/6667-1	70 x 140 cm	855	1.275
MO 6671/6665/6667-2	80 x 80 cm	705	
MO 6671/6665/6667-3	80 x 120 cm	850	1.270
MO 6671/6665/6667-4	80 x 140 cm	920	1.340
MO 6671/6665/6667-5	80 x 160 cm	1.065	
MO 6671/6665/6667-6	80 x 180 cm	1.075	1.495
MO 6671/6665/6667-7	80 x 200 cm	1.150	1.570
MO 6671/6665/6667-10	80 x 210 cm	1.200	1.620
MO 6671/6665/6667-11	90 x 90 cm	805	1.225
MO 6671/6665/6667-12	90 x 140 cm	990	1.410
MO 6671/6665/6667-13	90 x 200 cm	1.250	1.670
MO 6671/6665/6667-14	90 x 210 cm	1.305	1.725
MO 6671/6665/6667-9	Ø120 cm	1.030	1.450

OPTIONS - ADDITIONAL PRICE

Item No.	Product	Price
	Black-stained table top in veneer	150

ACCESSORIES

Item No.	Product	Price
MO 1110	Trolley, painted black, for rectangular tables with folding legs - for approx. 10 tables. W60xL150xH136 cm	2.200
MO 1111	Trolley, painted black, for circular tables. W85xD134XK101 cm. Internal width: 77 cm	1.960

BRUNCH WITH CONICAL WOODEN LEGS

SPECIFICATIONS & MEASUREMENTS

Description	Extremely durable table series with/without folding function.
Table height	74 cm
Table top	25 mm slim table top in plywood with chamfered plywood edge, lacquered or black stained, or straight ABS-edge
Table legs	Conical wooden legs are mounted in a 90 degree angle on the table top
Folding legs	Straight (MO 6666) or slanted with a 5 degree slant outwards (MO 6668)
Stacking	Trolleys for folding tables - 10 rectangular or 7 round



BRUNCH WITH CONICAL WOODEN LEGS

Item No.	Size	Tabel with conical wooden legs	Tabel with conical wooden legs - folding legs
		MO 6676	MO 6666 (straight)/MO 6668 (slanted)
MO 6676-0	70 x 120 cm	955	1.365
MO 6676-1	70 x 140 cm	1.030	1.440
MO 6676-2	80 x 80 cm	880	
MO 6676-3	80 x 120 cm	1.025	1.435
MO 6676-4	80 x 140 cm	1.095	1.505
MO 6676-5	80 x 160 cm	1.240	
MO 6676-6	80 x 180 cm	1.250	1.660
MO 6676-7	80 x 200 cm	1.325	1.735
MO 6676-10	80 x 210 cm	1.375	1.785
MO 6676-11	90 x 90 cm	980	1.390
MO 6676-12	90 x 140 cm	1.165	1.575
MO 6676-13	90 x 200 cm	1.425	1.835
MO 6676-14	90 x 210 cm	1.480	1.890
MO 6676-8	Ø90 cm	855	1.265
MO 6676-9	Ø120 cm	1.205	1.615

OPTIONS - ADDITIONAL PRICE

Item No.	Product	Price
	Table top and legs in black-stained oak	150
MO 6673	Hidden castors, not swiveling, per castor - only for rectangular and square tables	40

ACCESSORIES

Item No.	Product	Price
MO 1110	Trolley, painted black, for rectangular tables with folding legs - for approx. 10 tables. W60xL150xH136 cm	2.200
MO 1111	Trolley, painted black, for circular tables. W85xD134XK101 cm. Internal width: 77 cm	1.960

CONTACT

DESIGN: (2004) BUSK + HERTZOG

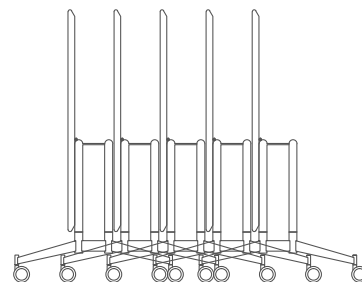
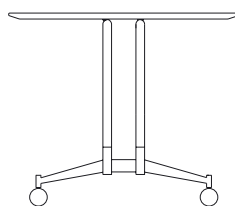

A flexible and mobile working table fitted with castors and horizontally stackable when the table top is raised – without lifting or using any strength.

WOOD & TREATMENTS



Oak,
transparent
lacquer



Oak, black-
stained

LINOLEUM



Pebble
4175
NCS 3502-Y



Ash
4132
NCS 5502-G



Black
4023
NCS 9000-N

LAMINATE



Grey
U1115 W
Duopal
NCS S4502-G



White
F7949 Soft
white Formica
RAL 9016



Graphite
F7837 Graphite
Formica
RAL8019



Wood pattern oak
F 5374 Elegant oak
Formica

STEEL COLOURS



Transverse steel
feet: Bright
chrome



Vertical tubular steel
tubes: Bright chrome
or powder lacquer in
black, matt grained
lacquer

CONTACT

DESIGN: (2004) BUSK + HERTZOG

SPECIFICATIONS & MEASUREMENTS

Description	Flip top table with castors, easily stored in minimal space
Table height	72 cm
Table top thickness	30 mm
Surface	Linoleum/laminate or oak veneer - only with beveled wooden edgings with oak.
Table edge	Straight ABS edge or beveled solid wooden edging in oak with transparent lacquer
Frame	Transverse foot and vertical tubes in steel
Details	Stack horizontally with only 22 cm between each table



CONTACT TABLE

Item No.	Size	Price with ABS-edge
MO 8591-4	140 x 80 cm	2.135
MO 8591-5	160 x 80 cm	2.205
MO 8591-6	180 x 80 cm	2.280
MO 8591-7	200 x 80 cm	2.350
MO 8591-8	140 x 100 cm	2.260
MO 8591-9	160 x 100 cm	2.350
MO 8591-10	180 x 100 cm	2.440
MO 8591-11	200 x 100 cm	2.530
MO 8591-12	200 x 108/80 cm	2.655

OPTIONS - ADDITIONAL PRICE

Product	Price
Bevelled wooden edge instead of ABS-edge	535

ACCESSORIES

Item No.	Product	Price
MO 8581	Contact frame extension, height 7,2 cm, per set (4 pcs.)	175
MO 8580	Linking device, per piece (2 pcs. per table)	40
MO 1631	Castor, 75 mm, with brake, per castor	80
MO 1630	Castor, 75 mm, without brake, per castor	80
MO 1700	Cable tray in metal, painted black, 49 cm for table length 120-140 cm - hangs between the frame tubes	170
MO 1701	Cable tray in metal, painted black, 77 cm for table length 160-200 cm - hangs between the frame tubes	170

CONTACT MEETING

DESIGN: (2024) BUSK + HERTZOG

SPECIFICATIONS & MEASUREMENTS

Description	Elegant meeting table, that can be configured to any need. It is possible to integrate various cabling solutions, see accessories.
Table height	74 cm
Table top thickness	25 mm
Straight ABS Edge	Straight ABS edge with laminate or linoleum with ABS edge in the same colour.
Beveled edge	Beveled plywood edge with transparent lacquer or black stain. Surface laminate or linoleum, or oak veneer.



CONTACT - SEMI-BOAT SHAPED TABLE WITH TWO COLUMNS

Model nr.	Size	Price
MO 6708-7	140 x 120cm	1.255
MO 6708-8	160 x 120 cm	1.320

CONTACT - SEMI-OVAL TABLE WITH TWO COLUMNS

MO 6708-4	140 x 120 cm	1.255
MO 6708-5	160 x 120 cm	1.320

CONTACT - RECTANGULAR LEAVES

MO 6708-9	140 x 120 cm	375
MO 6708-2	160 x 120 cm	420

EXAMPLES - TABLE COMPOSITIONS CONTACT MEETING BOAT SHAPED/OVAL

MO 6709-1/6709-11	280 x 120 cm m/3 columns	3.035
MO 6709-2/6709-12	320 x 120 cm m/3 columns	3.165
MO 6709-3/6709-13	420 x 120 cm m/4 columns	3.935
MO 6709-5/6709-15	480 x 120 cm m/4 columns	4.110

For other compositions - contact the factory

ACCESSORIES

Model nr.	Product	Price
MO 2998	Linking bracket, per pcs. (2 pieces are used per table)	25
MO 1705	Magnetic U-shaped wire management in metal, painted black - for use up along columns	30
MO 1709	Cable solution, 4 electrical plugs + USB-A and USB-C charger + PDU tray	1.040
MO 1710	Power Dot, black, height adjustable - 1x power/1x USB charger/ 1x USB-C/ 2x Feed-throughs (DK)	765

MO 1709



MO 1710



TRIO



A small cluster of coffee tables, circular, square and rectangular in solid oak or in plywood with all our standard laminate and linoleum colours. The tables are available in six sizes and three heights, making a vast number of combinations possible. Conical legs in solid oak, lacquered or black stained.

WOOD & TREATMENTS



Oak, transparent lacquer
 Oak, natural oil
 Oak, white-oil
 Oak, soap treatment
 Oak, black-stained

LINOLEUM



Pebble 4175 NCS 3502-Y
 Ash 4132 NCS 5502-G
 Black 4023 NCS 9000-N

LAMINATE



Grey U1115 W Duropol NCS S4502-G
 White F7949 Soft white Formica RAL 9016
 Graphite F7837 Graphite Formica RAL8019
 Wood pattern oak F 5374 Elegant oak Formica

TRIO

SPECIFICATIONS & MEASUREMENTS

Description	Trio lounge and coffee tables in a multitude of combinations
Table top thickness	25 mm
Table top	Solid oak with beveled edge, or plywood with linoleum/laminate surface, beveled plywood edge
Table legs	Solid oak

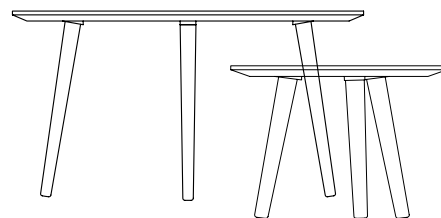

TRIO

Item No.	Size	Price for table top with laminate
MO 9580-1	Ø40 cm (Height: 40/45 cm)	285
MO 9580-2	Ø60 cm (Height: 40/45/50 cm)	410
MO 9580-3	Ø85 cm (Height: 40/45/50 cm)	630
MO 9580-4	110 x 60 cm (Height: 40/45/50 cm)	595
MO 9580-5	60 x 60 cm (Height: 40/45/50 cm)	470
MO 9580-6	125 x 70 cm (Height: 40/45/50 cm)	795

OPTIONS - ADDITIONAL PRICE

Product	Price
Table top with linoleum	80
Table top with in oak	155
Legs and table top/table top surface in black-stained oak	150
1 additional leg on Trio tables Ø 60 and Ø 85 cm to have 4 legs	185

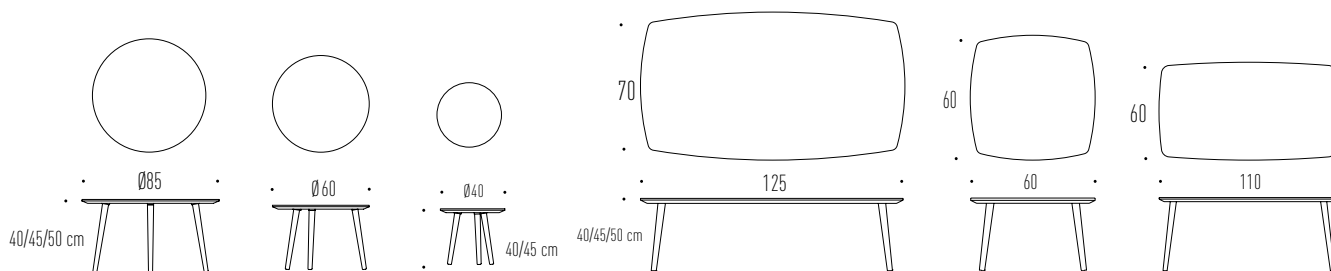

BAR TABLE WOOD

DESIGN: (2018) STRAND & HVASS

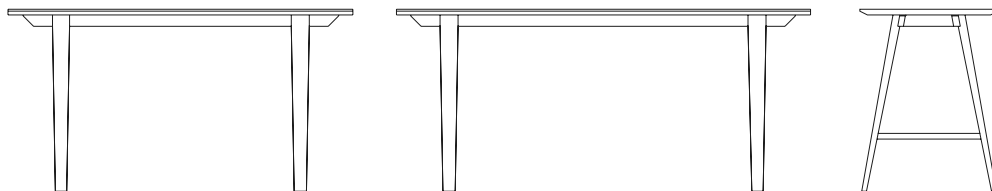

The table combines beautiful woodwork and elegant design with clean lines. The choice of materials contributes to stability and functionality. As the table is available in different sizes, heights and material combinations, it can be used for different purposes e.g. as a meeting table at the modern office or a bar table in restaurants.

WOOD & TREATMENTS

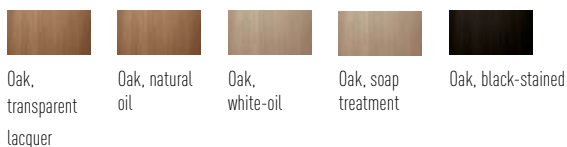

LINOLEUM

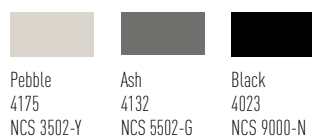

LAMINATE

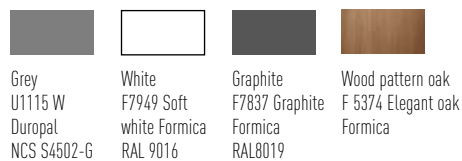

BAR TABLE WOOD

DESIGN: (2018) STRAND & HVASS

SPECIFICATIONS & MEASUREMENTS

Description	Sturdy long table, counter or bar table height, with beautiful woodwork and clean lines.
Table height	90 cm or 105 cm
Table top	Oak veneer, or surface in linoleum/laminate
Edge	Beveled edge in solid oak with transparent lacquer, soap treatment or black-stained
Frame	Solid oak



BAR TABLE WOOD - COUNTER HEIGHT 90 CM

Item No.	Size	Product	Price
MO 8700-1	200 x 80 cm x H90 cm	Laminate	2.340
MO 8700-1	200 x 80 cm x H90 cm	Linoleum	2.585
MO 8700-1	200 x 80 cm x H90 cm	Solid oak	4.800
MO 8700-2	240 x 80 cm x H90 cm	Laminate	2.530
MO 8700-2	240 x 80 cm x H90 cm	Linoleum	2.790
MO 8700-2	240 x 80 cm x H90 cm	Solid oak	5.165

BAR TABLE WOOD - BAR HEIGHT 105 CM

Item No.	Size	Product	Price
MO 8700-3	200 x 80 cm x H105 cm	Laminate	2.450
MO 8700-3	200 x 80 cm x H105 cm	Linoleum	2.695
MO 8700-3	200 x 80 cm x H105 cm	Solid oak	4.910
MO 8700-4	240 x 80 cm x H105 cm	Laminate	2.635
MO 8700-4	240 x 80 cm x H105 cm	Linoleum	2.900
MO 8700-4	240 x 80 cm x H105 cm	Solid oak	5.275

OPTIONS - ADDITIONAL PRICE

Product	Price
Black-stained frame and edging for tables with linoleum/laminate	230
Frame and table top in solid black-stained oak	460

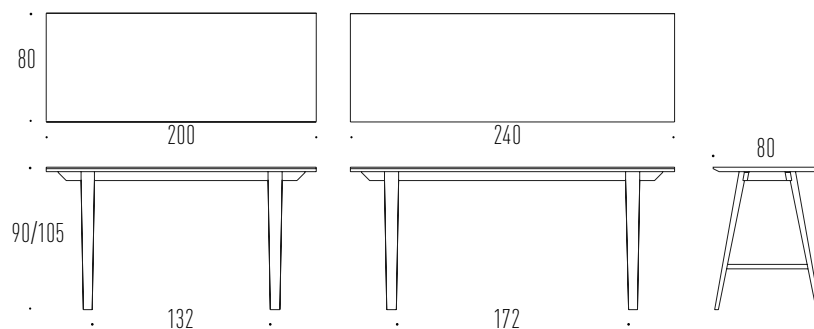

MEETING TABLE

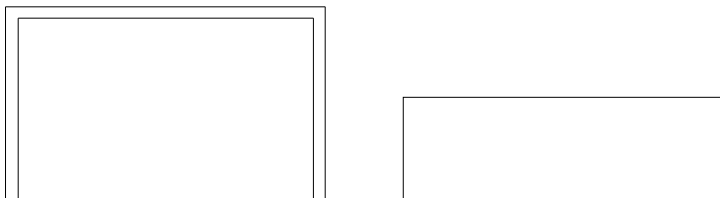

An elegant gable table in a light-weight material - the core of the table top consists of Honeycomb minimizing material consumption and, at the same time, makes the table light and very strong. Two built-in castors are mounted in one of the gables, so the table can be easily moved to the area where it is to be used. A bar table for many different rooms and particularly useful as a meeting bar table, with the option of both hang-up function for bar chairs and foot rest.

WOOD & TREATMENTS



Oak,
transparent
lacquer



Oak, black-
stained

LINOLEUM



Pebble
4175
NCS 3502-Y



Ash
4132
NCS 5502-G



Black
4023
NCS 9000-N

LAMINATE



Grey
U1115 W
Duropal
NCS S4502-G



White
F7949 Soft
white
Formica
RAL 9016



Graphite
F7837 Graphite
Formica
RAL8019



Wood pattern oak
F 5374 Elegant oak
Formica

MEETING TABLE

SPECIFICATIONS & MEASUREMENTS

Description	An elegant gable table in a light-weight material.
Table top thickness	Table top and gable: 55 mm
Table top and gable	Surface in laminate, linoleum or oak
Details	Two built-in castors are mounted in one of the gables
Sizes	W50-100 x L100-500 x H50-110 cm. For lengths over 250 cm, the table is divided into two and assembled in the middle + has a visible steel rail under the table top.
	Contact the factory for price information for the desired size(s) and executions

MEETING TABLE

Item No.	Sizes	Product	Price
MO 8691-1	160x60xH110	Laminate/Linoleum	2.655
MO 8691-1	160x60xH110	Veneer	2.855
MO 8691-2	200x60xH110	Laminate/Linoleum	3.050
MO 8691-2	200x60xH110	Veneer	3.275

OPTIONS - ADDITIONAL PRICE

Item No.	Product	Price
	Black-stained oak	230

ACCESSORIES

Item No.	Product	Price
	Hang-up pole for Pause bar chair - 160 cm	100
	Hang-up pole for Pause bar chair - 200 cm	135
	Foot rest - 160 cm	215
	Foot rest - 200 cm	240

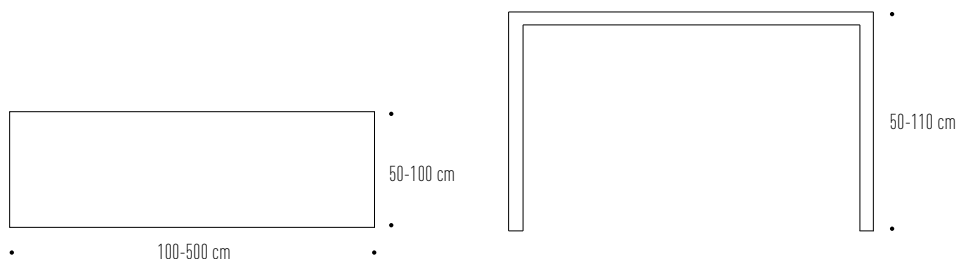

FABRIC, LEATHER & ARTIFICIAL LEATHER

Click on the individual fabric/leather/artificial leather for colours, specifications etc.

PRICE RANGES ARTIFICIAL LEATHER WOOL POLYESTER TREVIRA CS/FR GENUINE LEATHER

A [Valencia \(7\)](#)
[Dolce \(7\)](#) [Main Line Plus \(3\)](#) [Cura \(2\)](#)
[Era \(3\)](#)
[Quest \(3\)](#)

B [Illusion \(7\) PVC-free](#) [Blazer \(3\)](#)
[Crisp \(2\)](#)
[Fame \(2\)](#)
[Main Line Flax \(3\)](#)
[Morph \(2\)](#)
[Sumi \(3\)](#)
[Synergy \(3\)](#)
[Remix 3 \(1\)](#) [Go Uni \(2\)](#)
[Go Check \(2\)](#)
[Go Couture \(2\)](#)
[Step \(2\)](#)
[Step Melange \(2\)](#)

C [Atlas \(1\)](#)
[Hallingdal 65 \(1\)](#)

1 [Sydney \(6\)](#) Semi aniline
[Hero \(4\)](#) Surface treated
[Zea \(8\)](#)

2 [Savanne \(4\)](#) Semi aniline
[Triumph Crib \(4\)](#) Overfladebehandlet
[Vacona \(6\)](#) Aniline
[Fauna \(8\)](#)

Green letters indicate that the fabric or artificial leather is tested according to one or more of the following: Oeko-Tex®, EU- Ecolabel, Greenguard Certification, Indoor Advantage Gold Certificate. For leather green letters, indicate that the leather is tanned without chrome. Blue letters indicate that the leather is suitable for use in the Care sector.

Suppliers

(1) Kvadrat / (2) Gabriel / (3) Camira / (4) Sørensen Leather / (5) CA-MO Leather/ (6) Nevotex/ (7) Spradling / (8) Spoor Collection

FABRICS, ARTIFICIAL LEATHER AND LEATHER

Price ranges

The fabrics, as well as the fire-retardant CMHR polyurethane foam with high density: 60 kg/m³, have been chosen in due consideration of the fact that they should be able to withstand many years of hard daily wear regarding abrasion resistance, elasticity and cleaning

1. Abrasion resistance

According to the Technical Specifications from Danish Furnituremakers' Quality Control furniture fabrics used on a firm upholstery, which is on all our seating furniture, should fulfill the requirements of an abrasion resistance of 45.000 rubs according to the Martindale test method when exposed to normal use and 75.000 rubs in cases where the furniture is exposed to severe use as for instance in public environments. For less severe use a minimum of 25.000 rubs is needed.

2. Elasticity

On account of the from upholstery the fibres in the furniture fabric must have a certain degree of elasticity, i.e. the ability to contract after having been used, in order to avoid wrinkles or puckers which may occur when using cotton fabrics lacking this elasticity. In time leather stretches and wrinkles - more on a thick upholstery than on a thinner back upholstery. The thick leather types stretch less than thin leather.

3. Cleaning

As the major part of our seating furniture has a fixed upholstery, it is important that the furniture fabric is dirt-repellent and stands cleaning throughout a long period of time. This applies to woollen fabrics whereas Trevira CS and cotton fabrics attract dirt. This is why a removable seat cover should be chosen for seating furniture with a Trevira CS fabric in order to make the seat cover washable. Leather must have a surface treatment.

We reserve the right to reject furniture fabrics, vinyls or leather that we find unsuitable for the purpose of the furniture

Steel surfaces

Bright chrome or black matt grained lacquer at standard price. Powder coating in RAL 9006 aluminium in special colours at an additional price - shown for each product in the price list.

TERMS OF SALE AND DELIVERY



1. Extent and duration

1.1.

Terms of sale and delivery are valid for all offers, orders, deliveries and payments where Magnus Olesen A/S is a supplier or a sub-supplier, unless an explicit written deviation has been made.

1.2

The Buyers indication of special conditions in tender material, orders, purchase conditions will only be considered agreed if an explicit agreement has been made. These terms of sale and delivery have priority compared to purchase terms and conditions unless a separate agreement has been made.

1.3

The terms of sale and delivery will take effect from 1st June 2024 and will be valid until other information is given by Magnus Olesen A/S.

2. Offers

2.1

Every offer is given errors, omissions and other discrepancies excepted

2.2

Offers are binding for Magnus Olesen for 30 days from the date of the offer unless another time limit is explicitly expressed in the offer.

3. Sample furniture

3.1

Sample furniture is available for named projects for a net value for more than EUR 7.000 In connection with sample furniture Magnus Olesen will take on the freight to the dealer's warehouse whereas the dealer will be responsible for handling the return freight in the original packaging. Magnus Olesen must be contacted prior to returning the sample furniture - you will then have a return number, so the furniture may be credited correctly on return to the factory. Sample furniture which is not returned within 30 days will be invoiced to the dealer.

4. Ordering/order confirmation

4.1

A binding agreement has been made when the Buyer receives a written order confirmation.

4.2

Together with these terms of sale and delivery the order confirmation is considered the valid basis for every commerce between Magnus Olesen and the Buyer.

4.3

Objections to the content of the order confirmation must be given in writing to Magnus Olesen no later than 2 days after the date of the order confirmation. Objections made later than that will be at a fee.

4.4

Cancellation of orders can only happen with the written acceptance from Magnus Olesen and against a simultaneous payment of a fee of 25% of the confirmed sales price. In case of custom made furniture a cancellation can be made against a fee of 75% of the confirmed price.



5. Delivery and time of delivery

5.1

CIP Freight carriage and insurance paid to the dealer's warehouse address. For deliveries of orders for a total net amount below EUR 1.000 a transport fee of 10% of the net order amount is added - the minimum fee is EUR 70. For delivery to end users a transport fee of EUR 215 will be added regardless of the order amount. Delivery includes unloading at the door or on loading platform, where as the dealer is responsible for carrying the furniture in as well as for unpacking and mounting the furniture. Direct deliveries on a requested date will only be coordinated as far as the forwarder, normally used by Magnus Olesen, is able to meet the request. An additional freight cost will be added if an alternative forwarder is used.

5.2

Delivery from Magnus Olesen within 4 working weeks, counting from the time of delivery indicated in the order confirmation will be considered as delivered in due time. The Buyer cannot claim damages due to delays from the seller.

5.3

In case of a delay owing to the Buyer's circumstances the Buyer is obliged to pay the purchase price at the agreed time and the Buyer must also pay the cost of storage etc.

6. Prices and terms of payment

6.1

Magnus Olesens prices are those valid on the day of the order unless another written agreement has been made.

6.2

Cash payment on delivery at the latest, unless other terms of payment have been agreed upon separately and have been confirmed in writing by the seller. Credit will be granted provided that a debtor insurance is obtained - if not, payment or bank guarantee at buyer's expense before starting production, unless another agreement is made in writing. After the due date of payment a 1.5% interest per month + a fee will be charged. If a payment is not made on the due date the seller has the right to cancel the purchase immediately and without further notice.

The ownership of the sold items remains in all respects with the seller until the purchase amount and all other costs involved in the purchase are paid effectively by the buyer.

6.3

Payment must be done as a bank transfer to Magnus Olesen's account at Buyer's expense unless another mode of payment is agreed in writing.

7. Warranty

Magnus Olesen grants a 5 year warranty against manufacturing defects in materials and constructions in standard products and standard executions. The warranty never covers ordinary wear and aging, wear and tear on covers and surfaces (including surface treatments). The warranty presupposes normal use of the furniture in a normal indoor climate. When using customer's own material (fabric/vinyl/leather) the Buyer is holding all responsibility for the material's suitability for the concerned product and its purpose. Small knots, colour differences, more or less visible annual rings in the wood are signs of authenticity and are not considered as defects.

8. Special products and executions

Our 5 year warranty will not be valid for orders for special products and executions which are not part of our standard range and supplementing deliveries cannot be guaranteed. Furthermore our time of delivery on such products may often be longer than on standard products and executions.

9. Sustainability fee

9.1

A sustainability fee of EUR 15 will be added to all invoices - for further information with regards to our environmental initiatives - please contact the factory.



10. Defects and complaints

10.1

Complaints regarding defects or flaws in the product must be made in writing no later than 7 days after the day of delivery.

Complaints regarding transport damage or other defects or flaws visible prior to the unpacking of the product must be made in writing by the Buyer towards the carrier when receiving the product and be noted on the delivery note. Complaints regarding transport damages which are not visible prior to the unpacking of the goods must be made in writing with photos of the damages in question attached no later than 7 days after delivery. If not, Magnus Olesen cannot be made responsible for the damage.

11. Force Majeure

10.1

The Buyer cannot make a claim towards Magnus Olesen regarding breaches of contract, if a delay in delivery is due to an event beyond the control of Magnus Olesen.

12. Venue and choice of law

These terms of sale and delivery are subject to Danish law.

13. Time of delivery (excl. of transport)

Upholstered surfaces : approx. 5 working weeks

Surfaces in linoleum/laminate: approx. 4 working weeks

Table top surf. in natural wood: approx. 5 working weeks

NB.

Any changes must be made 4 working weeks before dispatch for upholstered surfaces and table tops with wooden surface 5 weeks prior to dispatch.

We reserve the right to make alterations to the models and shall not be liable for any printing errors



SHOWROOM

FREDERIKSGADE 7, ST. TH.
1265 KØBENHAVN K, DANMARK



MAGNUS OLESEN